



polycarbonate & more



NUOVE APPLICAZIONI PROFITTEVOLI
PER TECNOPOLIMERI INNOVATIVI
E POLIMERI TRADIZIONALI
NELL'INDUSTRIA DEL MOBILE

*NEW PROFITABLE APPLICATIONS
FOR INNOVATIVE TECHNOPOLYMERS
AND COMMODITY POLYMERS
INTO THE FURNITURE BUSINESS*



BACKGROUND



GRANDSOLEIL è una unità operativa di business appartenente al gruppo IGAP. IGAP è un gruppo italiano di proprietà della famiglia Pezzi, ed ha la sua origine all'inizio degli anni sessanta. Opera con successo in tutta Europa, anche grazie ad alcune consociate in Francia, Spagna, Grecia, Germania e Portogallo, nei settori degli articoli da giardino, per il camping ed il tempo libero, del mobile da giardino e da esterno, dell'open space e del giocattolo. In particolare, il gruppo Igap ha consolidato la sua leadership europea acquisendo nel corso del tempo, come clienti, i principali gruppi e catene europee della distribuzione moderna.

Il gruppo Igap ha la propria sede direzionale ed i propri magazzini principali a Cogozzo di Viadana, in provincia di Mantova, ed opera in quella localizzazione su di una superficie totale di 370.000 mq, garantendo risposte tempestive ed efficienti alle richieste di mercato, così come ottimi standard di servizio. Da sempre l'intera organizzazione aziendale è posta al servizio della propria clientela, in uno spirito di totale lealtà e di ampia disponibilità.

Nel 2005 il gruppo Igap ha assunto il controllo dell'azienda Grazioli Grand Soleil, essendo Grandsoleil il brand storicamente riconosciuto come leader, per i mobili da esterno e da giardino, per l'open space ed i giocattoli, tutte categorie di prodotto fabbricate, a partire dal polipropilene, negli stabilimenti localizzati a Canneto sull'Oglio, sempre in provincia di Mantova.

Dopo un periodo di tre anni dedicato alla ristrutturazione e riorganizzazione di GRANDSOLEIL in unità operativa, nella seconda metà del 2008 IGAP ha deciso di iniziare un importante piano di investimento a Canneto sull'Oglio, piano inteso a riposizionare questo marchio leader di mercato, sulla base di una nuova missione

che potrebbe essere sintetizzata come segue: "Sviluppare, industrializzare, produrre e commercializzare nuove applicazioni profittevoli, per i polimeri tradizionali e per i tecnopolimeri innovativi, nell'industria del mobile".

NUOVA MISSIONE PER L'UNITÀ OPERATIVA GRANDSOLEIL



Facendo assegnamento sulla tradizione manifatturiera e sul rilevante potenziale produttivo già installato di GRANDSOLEIL che opera su una superficie totale coperta di ca. 75.000 mq, destinata alla produzione ed a magazzino, e situata a soli 25 km. dalla sede direzionale di Viadana, IGAP ha deciso di adottare due direzioni di marcia principali per i futuri sviluppi dell'unità operativa nel medio periodo. Da un lato, dal punto di vista dei tecnopolimeri innovativi, IGAP ha introdotto il policarbonato, così come nuovi tipi di tecnopolimeri a base di polipropilene, nella produzione in volume di sedie, tavoli e sgabelli, ed in particolare nuove generazioni di polipropilene variamente modificato ed ingegnerizzato per la produzione di sedie leggere, con struttura complessa e superfici altamente lucide; d'altro canto, dal punto di vista dei polimeri tradizionali, ha deciso di esplorare la possibilità di imitare, tramite la tecnologia degli stampi a iniezione a gas, dapprima applicata al polipropilene standard, ed al presente anche a polimeri di riciclo, le superfici intrecciate in rattan naturale o wicker

artificiale. Tutto ciò per aprire la strada all'ancor più ambizioso progetto dell'imitazione delle superfici fibro-legnose piane, cioè "tout court" del legno.

Per concretizzare questi sviluppi è stato completato un piano di investimenti, per un totale di 40 milioni di euro, piano partito all'inizio del 2009, e che ha portato il numero di presse operanti negli stabilimenti, dalle passate 65 alle presenti 89, posizionandosi tutte le nuove 24 presse inserite sull'attuale frontiera tecnologica del settore industriale, perché consentono a GRANDSOLEIL di lavorare con elevata velocità ed inimitabile flessibilità, in modo alternativo, tanto sui prodotti in policarbonato, quanto su tutti quelli realizzati con il contributo dei nuovi tecnopolimeri introdotti. Nello periodo considerato GRANDSOLEIL ha introdotto in produzione 30 nuovi stampi ad iniezione a gas, tecnologicamente avanzati, solo per quanto riguarda le sedie in policarbonato e nei tecnopolimeri innovativi a base di polipropilene, così come 18 nuovi stampi, sempre a iniezione a gas, per una famiglia di sedie e di prodotti di arredo eterogenei, con superficie in polipropilene standard, o in polimeri di riciclo, imitando il rattan naturale, o il wicker artificiale, intrecciati. E il numero di nuovi stampi che GRANDSOLEIL sta sviluppando cresce ogni giorno.

La capacità produttiva annuale, solo per le sedie in policarbonato, ha superato le quattro milioni di unità, ovvero più di 12.000 sedie di policarbonato al giorno, fatto questo che colloca IGAP-GRANDSOLEIL nella posizione di leadership europea di volume nel particolare segmento.

I nostri clienti, in tutto il mondo, hanno pertanto la possibilità di contare su un numero ragguardevole di prodotti altamente innovativi che consentono, da un lato, volumi di vendita significativi, a causa dei costi di produzione estremamente contenuti, del notevole rapporto qualità/prezzo e della rapidità dei tempi di fornitura (tutti fatti dovuti alla tecnologia di prim'ordine con cui GRANDSOLEIL sta lavorando, dall'altro, margini attrattivi, totalmente differenti da quelli del business tradizionale, basato sul polipropilene standard. Condividi con noi questi entusiasmati sviluppi.



BACKGROUND

GRANDSOLEIL is a business unit belonging to the IGAP group. IGAP is an Italian group owned by the Pezzi family, and was established at the beginning of the sixties. It has been operating successfully across Europe, thanks to some direct subsidiaries in France, Spain, Greece, Germany and Portugal, in the gardening, leisure and camping articles, outdoor furniture, open space and toy business.

In particular, the Igap group has been consolidating its European leadership and is at present supplying almost all the relevant European chains and groups.

The Igap group has its headquarters and main warehousing facilities located in Cogozzo di Viadana, close to Mantua (Northern Italy), and is operating there on a surface of 370.000 square meters, in order to guarantee the best service and a quick and efficient response to the market requests.

The ultimate technological possibilities, the young management, the professional expertise and the loyalty to the customers allow IGAP to be a reliable partner.

In 2005 the Igap group took over the Grazioli Grand Soleil company, being Grandsoleil the leading umbrella brand in Italy for outdoor furniture, gardening, open space and toys, mainly manufactured out of polypropylene, in the production facilities located in Canneto S/Oglio, also belonging to the Mantua province.

After a 3-year period devoted to the general restructuring and reorganizing the taken over company, in the second half of 2008 IGAP decided to start a remarkable investment plan for the GRANDSOLEIL business unit, intended to reposition this leading brand on the European market, on the ground of a new mission which could be stated as it follows:

“Develop, implement, produce and sell new profitable applications for commodity polymers and innovative technopolymers into the furniture business

”.Banking on the strong structure and production potential of GRANDSOLEIL, working on a total covered surface of 75.000 squared meters, as for production and warehousing facilities, located 25 km. far from the headquarters in Viadana, IGAP decided to adopt two main directions for the future development of the business unit in the medium run.

On the one side, from the point of view of innovative technopolymers, IGAP decided to introduce polycarbonate, as well as innovative polypropylene-derived compounds, into the production in volume of furniture, and first of all, specifically, of chairs, barstools and tables, in particular new generations of engineered and modified glossy polypropylenes for the production of very light and structurally complex chairs; on the other side, from the point of view of the commodity polymers, to explore the possibility to mimic, through the technology of gas injection moulding, till present applied to standard polypropylene, today also to recycled polymers, different kinds of woven natural rattan (and artificial wicker) surfaces. This development is intended to be the first step on the way leading to the more ambitious goal of imitating in general and “tout court” the wood surfaces.



NEW MISSION FOR THE GRANDSOLEIL BUSINESS UNIT



According to these main decisions, a first 40-million euro investment plan has been implemented, which, did start at the beginning of 2009, is actually at the end of its implementation, and was bringing, the number of presses working in the plant, from the past 65 to 89, being all the new presses particularly powerful and state-of-the-art machinery, because all of them allow GRANDSOLEIL to work at high speed and with unique flexibility on both polycarbonate products, and products based on the new innovative polymers which GRANDSOLEIL is launching. In the same period GRANDSOLEIL has been introducing in production 30 new technologically advanced gas-injection moulds, only for chairs being manufactured out of polycarbonate and innovative polypropylene-derived compounds, and 18 new moulds for a family

of different products with standard polypropylene surface, imitating the woven natural rattan (wicker) surface. And the number of new moulds GRANDSOLEIL is having developed and produced is continuously growing.

The yearly capacity only for polycarbonate chairs is exceeding already the 4 million pieces, that is more than 12.000 polycarbonate chairs per day, fact which puts GRANDSOLEIL in the position of European leadership as for the production in volume of these particular chairs.

Our customers, all over the world, have at present therefore the possibility to rely on a growing number of highly innovative products, allowing, at the same time significant volumes, because of the very low production costs, a remarkably high quality/price ratio, as well as a very fast delivery time (all is due to the state-of-the-art technology GRANDSOLEIL is working with). Margins are very attractive, totally different if compared to the traditional business, based on commodity polymers.

Share with us these enticing developments. “Keep an eye upon us”, to create a motto from the brand name UPON, given to the new range of chairs.

**up
on**[®]

Eyes upon us.

ROBRI150 IS

PAH
100%
free

PAH - 多環芳烴 - PAH - 多環芳烴 - PAH - 多環芳烴
PAH - 多環芳烴 - PAH - 多環芳烴 - PAH - 多環芳烴
PAH - 多環芳烴 - PAH - 多環芳烴 - PAH - 多環芳烴
PAH - 多環芳烴 - PAH - 多環芳烴 - PAH - 多環芳烴
PAH - 多環芳烴 - PAH - 多環芳烴 - PAH - 多環芳烴
PAH - 多環芳烴 - PAH - 多環芳烴 - PAH - 多環芳烴
PAH - 多環芳烴 - PAH - 多環芳烴 - PAH - 多環芳烴
PAH - 多環芳烴 - PAH - 多環芳烴 - PAH - 多環芳烴
PAH - 多環芳烴 - PAH - 多環芳烴 - PAH - 多環芳烴
PAH - 多環芳烴 - PAH - 多環芳烴 - PAH - 多環芳烴

UPON[®]

Eyes upon us.

CATALOGO - CATALOGUE

100% MADE IN ITALY

BY



PERCHÈ IL POLICARBONATO PER LE SEDIE UP-ON?

Il policarbonato ha trovato le sue utilizzazioni più conosciute sino ad anni recenti nella produzione di oggetti per l'elettronica di consumo (i CD e i DVD, in particolare, grazie alle sue proprietà elettriche), così come nelle soluzioni tecnologicamente avanzate per il settore delle costruzioni, ogni volta che una trasparenza ed una luminosità di elevata qualità sono richieste, insieme alla leggerezza, associate però ad una estrema resistenza del materiale; ciò grazie, da un lato, alle sue distintive proprietà ottiche (il policarbonato infatti è più trasparente della maggior parte dei vetri silicei), e, d'altra parte, al suo essere molto più leggero del vetro, ma allo stesso tempo molto resistente (il policarbonato ha infatti una notevole resistenza agli urti ed ai colpi, e mostra una marcata attitudine a sopportare elevate pressioni, sia statiche, che dinamiche, tanto nella direzione verticale, quanto in quella orizzontale).

Oltre a ciò, anche la possibilità di lavorare sul policarbonato con la tecnologia degli stampi ad iniezione a gas è altamente apprezzata, a differenza di quanto accade con più tradizionali ed economici sostituti del vetro, come ad esempio il vetro acrilico (tecnicamente parlando il metilmetacrilato, oppure, commercialmente parlando, il vetro acrilico, o plexiglass) che può essere solo utilmente termoformato da lastre piane.

Per quanto riguarda l'industria del mobile, ed in particolare della sedia, l'utilizzazione del policarbonato è stata limitata sino al presente, alla fascia più elevata dei prodotti di design, combinando la brillantezza della superficie in policarbonato con la possibilità del design innovativo, consentita dalla libertà di forma che la tecnologia degli stampi ad iniezione a gas garantisce. Il prezzo medio di questi prodotti ha pertanto discriminato sino ad ora la maggior parte dei consumatori comuni, restringendo concretamente la possibilità di acquisto ad una elite di consumatori innovativi.



La missione di GRANDSOLEIL è al contrario quella di rendere il policarbonato alla portata del consumatore medio, mettendo questo materiale in competizione anche con la più tradizionale materia prima per l'industria del mobile, ovvero il legno. Affidandosi alla qualità ed efficienza della propria produzione, dovuta alla tecnologia avanzata delle presse e degli stampi, traendo vantaggio dalle proprietà ottiche del policarbonato, così come dalla sua estrema resistenza, essendo anche in condizione di sviluppare strutture e forme nella più ampia libertà espressiva, GRANDSOLEIL può effettivamente rendere oggi obsoleta la tradizionale distinzione tra sedie da interno e da esterno, grazie alla versatilità garantita dal policarbonato (e dai tecnopolimeri innovativi derivati dal polipropilene), e può commercializzare il policarbonato come una alternative economicamente attraente, ed otticamente superiore a differenti materiali tradizionali, tra cui il legno, dando anche -sempre in confronto ai materiali tradizionali- risultati comparabili, o superiori, per quanto riguarda la robustezza e la leggerezza. Il rischio del graffio può essere significativamente ridotto, adottando le corrette "ricette" chimiche per il policarbonato, e con specifici trattamenti superficiali. Entrambe le cose sono difficilmente fattibili, per esempio, con il metacrilato, che mostra purtroppo sempre una forte predisposizione al graffio.

Essendo cosciente del complesso di queste possibilità che nel loro insieme garantiscono elevati volumi di vendita, GRANDOLEIL sta intenzionalmente orientando il proprio design nell'alveo della grande e classica tradizione della sedia italiana tra gli anni cinquanta e novanta, principalmente realizzata in legno, provvedendo una rilettura ed una ridefinizione di quella tradizione, alla luce delle nuove possibilità espressive offerte dal policarbonato.

Infine, anche in confronto alle semplici sedie dotate di gambe metalliche e con seduta realizzata in acrilico termoformato, la efficienza e la velocità raggiunte dalla produzione di GRANDSOLEIL, realizzata in policarbonato, hanno portato i costi di quest'ultimo significativamente vicini a quelli del metacrilato, fornendo un prodotto che, tuttavia, è strutturalmente più robusto, sia come capacità di sopportare pressione e peso, sia in termini di resistenza all'urto. Ciò, poiché il metacrilato, specie se è stato termoformato in modo significativo, e forato, si comporta in modo fragile, talvolta in modo imprevedibile, specialmente sotto l'azione di una forza d'urto.

Accanto a ciò il policarbonato ha una maggiore trasparenza del metacrilato (che non è mai trasparente quanto i vetri silicei). Ciò è vero soprattutto nella versione non colorata, laddove il metacrilato mostra un residuo giallo di fondo che non può essere totalmente rimosso.

In ogni modo, il confronto con il metacrilato deve essere necessariamente ristretto a pochi esempi, perché il metacrilato può essere utilizzato solo per semplici sedute, a causa delle limitazioni del processo di termoformatura da lastra piana, piuttosto che per sedie complete, che, al contrario, rappresentano la vera possibilità del policarbonato, grazie alla tecnologia degli stampi ad iniezione a gas. Il policarbonato rende libero il design della sedia.

Ultimo, ma non minore dettaglio, la introduzione, accanto al policarbonato, di tecnopolimeri innovativi, derivati dal polipropilene (IGAP ha registrato questi materiali con il trademark di HIGLOPP ed HIGHMOPP) darà ai nostri clienti la possibilità di commercializzare sedie con una superficie brillante e high glossy, che imitano perfettamente, dal punto di vista visivo, la superficie in policarbonato, nella versione lucida, ma sono caratterizzate da un livello di prezzo, nel range UPON, molto vicino a quello delle sedie in polipropilene standard. GRANDSOLEIL sta rendendo la cosa possibile, passo dopo passo, anche per sedie molto leggere e strutturalmente complesse, incluse, nel futuro prossimo anche le sedie con gambe metalliche cromate.

Anche questa risulterà una innovazione significativa per il mercato, poiché le superfici brillanti ed ultralucide rappresentano al presente, e nel prossimo futuro, un trend di sicuro successo, soprattutto per il pubblico dei giovani consumatori.

WHY POLYCARBONATE FOR THE UPON CHAIRS?

Polycarbonate has been finding its most relevant utilization until recent years, in the consumer electronics business (CDs and DVDs, in particular, thanks to its electrical properties), as well as in many hi-tech solutions for the building sector, every time high-quality transparency is needed, together with lightness, combined to an extreme strength of the material; this thanks, on the one side, to its distinctive optical properties (it is clearer than the most part of silica glasses), and, on the other side, to its being much lighter than glass, but at the same time very strong (very high resistance to hits and remarkable attitude at bearing static and dynamic weight pressures, both in the vertical and horizontal direction).

In both cases, also the possibility to work on polycarbonate with the technology of gas-injection mouldings has been highly appreciated, if compared to the cheaper and more traditional substitute for glass, that is the acrylic glass (technically speaking methyl methacrylate, or also, commercially speaking, acrylic or plexiglass) which can be only thermoformed.

As for the furniture business, and in particular the chair business, the utilization of polycarbonate has been limited until present time to the very hi-end design products, combining the sparkling surface of polycarbonate with the possibility of innovating design, because of freedom of forms granted by the technology of injection mouldings. The average price of these products has been so far discriminating the most part of common consumers, restricting the possibility to buy only to an elite of innovative customers.

The mission of GRANDSOLEIL is on the contrary to bring polycarbonate at reach of the average consumer, putting this material in competition with the most traditional raw material in the chair business, which is wood. Relying on its production efficiency and quality, due to the state-of-the-art machinery and moulds GRANDSOLEIL is working with, taking advantage of the optical properties, as well as of the extreme strength of polycarbonate, being also in the condition to choose structures and designs with wide freedom,

GRANDSOLEIL can actually make obsolete the traditional distinction between indoor and outdoor chairs, thanks to the versatility allowed by polycarbonate (and by innovative polypropylene-derived compounds), and can sell polycarbonate as a trendy and optically superior alternative for different traditional materials, like wood, giving also – always in comparison to traditional materials – comparable or superior results, as for strength, and as for lightness.

The risk of scratching can be significantly reduced, by adopting the right chemical recipe for the polycarbonate, and through superficial treatment. Both things are not feasible, for instance, with methacrylate, which always remains very prone to scratching. Being aware of this possibilities, which are in fact triggering the real volumes, GRANDSOLEIL is intentionally orienting its design towards the great and classic tradition of the Italian chairs of the fifties, of the sixties, and of the nineties, mainly made out of wood, providing an updated redefinition of that heritage, at the light of the new possibilities allowed by polycarbonate.

Finally, also in the particular case of simple chairs with metal legs, with seat and backrest entirely made out of thermoformed methacrylate, the efficiency and speed reached by production bring polycarbonate costs down, and significantly closed to the cost level of methacrylate, providing, at the same time, a product which is, structurally, much stronger, as for the attitude at bearing weight pressures, and in terms of resistance to hits. This because methacrylate, in particular after being thermoformed and drilled, behaves in a brittle, and sometimes unpredictable manner, when loaded, especially under an impact force. Beside that, polycarbonate has a higher transparency than methacrylate, because methacrylate is not as clear as the silica glasses, and, in particular, in the cristal clear version, shows a background yellow component, which can not be removed.

Anyway, a comparison to methacrylate has necessarily to be restricted to only few examples, because methacrylate can be used only for simple seats and backrests, due to the limitations of the thermoforming process, more than for complete chairs, which is, on the contrary, the true possibility of polycarbonate, thanks to the workability of this material inside injection mouldings. Polycarbonate is making free the design for chairs.

Last, but not least, the introduction for the UPON chairs, of innovative polypropylene-derived chemical compounds (IGAP registered these materials under the trademark of HIGLOPP and HIGHMOPP) will give our customers the possibility to rely on chairs with sparkling and hi-glossy surface, perfectly imitating, from the point of view of the visual effect, a polycarbonate surface, in the glossy solid version, but with an entry price point level for the UPON range, very closed to the one of the standard polypropylene chairs. GRANDSOLEIL is step-by-step making this possible also for very light and structurally complex chairs, including, in the near future, also the chairs with metal chromed legs.

This will be also a breakthrough for the market, due to the high glossy surfaces being at present, and in the medium run, very trendy, especially for young consumers.



up[®]
on

Eyes upon us.





B-SIDE

Sedia in policarbonato trasparente
Transparent polycarbonate chair

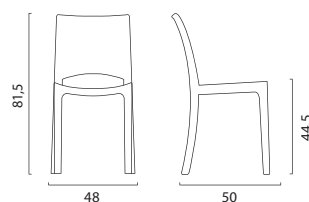

Dimensioni / Dimensions (cm.)

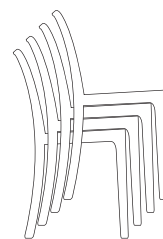

Sedia impilabile
Stackable chair



Dati tecnici e logistici / Technical & logistic details

Codice Item code	Codice Ean Ean code	Colore Color	Peso / Weight (Kg.):
S6315TR	8005465 822589	TRASPARENTE / CRISTAL CLEAR	4,85
S6315TRRR	8005465 890434	ROSSO RUBINO / RUBY RED	
S6315TRY	8005465 822817	FUMÈ / SMOKED GREY	
S6315TRBE	8005465 890441	BLU ELETTRICO / ELECTRIC BLUE	

Imballo pallet / Pallet packing	
Pz. pallet / Pcs./Pallet :	16
Misure pallet / Pallet dim. (cm.):	100 x 48 x h. 177
Pz. Bilico / Pcs. Truck :	1.120
Pz. 40' CTR / Pcs. 40' CTN :	960

Colori / Colors



TRASPARENTE
CRISTAL CLEAR



ROSSO RUBINO
RUBY RED



FUMÈ
SMOKED GREY



BLU ELETTRICO
ELECTRIC BLUE

LITTLE ROCK

Sedia in policarbonato trasparente
Transparent polycarbonate chair

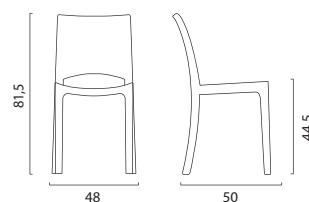

Dimensioni / Dimensions (cm.)

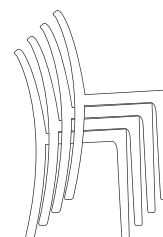

Sedia impilabile
Stackable chair



Dati tecnici e logistici / Technical & logistic details

Codice Item code	Codice Ean Ean code	Colore Color	Peso / Weight (Kg.) :	4,85
S6325TR	8005465 968249	TRASPARENTE / CRISTAL CLEAR	Imballo pallet / Pallet packing	
S6325TRRR	8005465 968263	ROSSO RUBINO / RUBY RED	Pz. pallet / Pcs./Pallet :	18
S6325TRMAL	8005465 968300	MARRONE CHIARO / LIGHT BROWN	Misure pallet / Pallet dim. (cm.) :	100 x 48 x h. 187
S6325TRY	8005465 968256	FUMÈ / SMOKED GREY	Pz. Bilico / Pcs. Truck :	1.260
			Pz. 40' CTR / Pcs. 40' CTN :	1,080

Colori / Colors



TRASPARENTE
CRISTAL CLEAR



ROSSO RUBINO
RUBY RED



MARRONE CHIARO
LIGHT BROWN



FUMÈ
SMOKED GREY

NILO

Sedia in policarbonato trasparente
Transparent polycarbonate chair

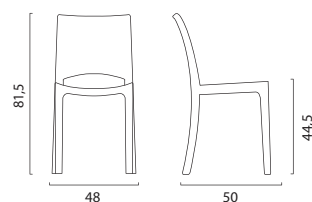

Dimensioni / Dimensions (cm.)

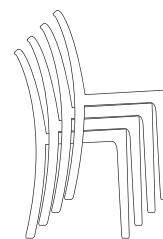

Sedia impilabile
Stackable chair



Dati tecnici e logistici / Technical & logistic details

Codice Item code	Codice Ean Ean code	Colore Color	Peso / Weight (Kg.) :	4,95
S6335TR	8005465 969093	TRASPARENTE / CRISTAL CLEAR	Imballo pallet / Pallet packing	
S6335TRRR	8005465 969123	ROSSO RUBINO / RUBY RED	Pz. pallet / Pcs./Pallet :	18
S6335TRMAL	8005465 969116	MARRONE CHIARO / LIGHT BROWN	Misure pallet / Pallet dim. (cm.) :	100 x 48 x h. 187
S6335TRY	8005465 969109	FUMÈ / SMOKED GREY	Pz. Bilico / Pcs. Truck :	1.260
			Pz. 40' CTR / Pcs. 40' CTN :	1,080

Colori / Colors



TRASPARENTE
CRISTAL CLEAR



ROSSO RUBINO
RUBY RED



MARRONE CHIARO
LIGHT BROWN



FUMÈ
SMOKED GREY

FEMME FATALE

Sedia in policarbonato trasparente
Transparent polycarbonate chair

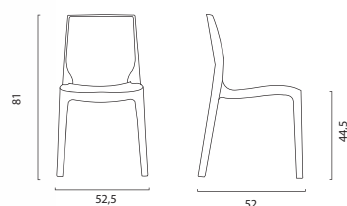

Dimensioni / Dimensions (cm.)

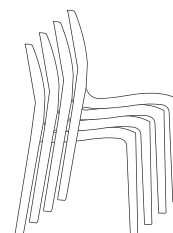

Sedia impilabile
Stackable chair



Dati tecnici e logistici / Technical & logistic details

Codice Item code	Codice Ean Ean code	Colore Color	Peso / Weight (Kg.) :	5,20
S6317TR	8005465 890946	TRASPARENTE / CRISTAL CLEAR	Imballo pallet / Pallet packing	
S6317TRRR	8005465 890960	ROSSO RUBINO / RUBY RED	Pz. pallet / Pcs./Pallet :	16
S6317TRY	8005465 890984	FUMÈ / SMOKED GREY	Misure pallet / Pallet dim. (cm.) :	105 x 48 x h. 170
S6317TRMAV	8005465 893046	MALVA / PURPLE	Pz. Bilico / Pcs. Truck :	1.120
			Pz. 40' CTR / Pcs. 40' CTN :	960

Colori / Colors



TRASPARENTE
CRISTAL CLEAR



ROSSO RUBINO
RUBY RED



FUMÈ
SMOKED GREY



MALVA
PURPLE

GRUVYER

Sedia in policarbonato trasparente
Transparent polycarbonate chair

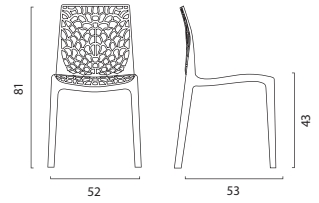

Dimensioni / Dimensions (cm.)

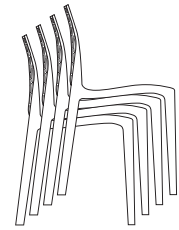

Sedia impilabile
Stackable chair



Dati tecnici e logistici / Technical & logistic details

Codice Item code	Codice Ean Ean code	Colore Color	Peso / Weight (Kg.):	5,05
S6316TR	8005465 822725	TRASPARENTE / CRISTAL CLEAR	Imballo pallet / Pallet packing	
S6316TRRR	8005465 890342	ROSSO RUBINO / RUBY RED	Pz. pallet / Pcs./Pallet :	16
S6316TRY	8005465 890472	FUMÈ / SMOKED GREY	Misure pallet / Pallet dim. (cm.):	105 x 48 x h. 170
			Pz. Bilico / Pcs. Truck :	1.120
			Pz. 40' CTR / Pcs. 40' CTN :	960

Colori / Colors



TRASPARENTE
CRISTAL CLEAR



ROSSO RUBINO
RUBY RED



FUME
SMOKED GREY

up
on[®]

Eyes upon us.



JOKER

Poltrona in policarbonato trasparente
Transparent polycarbonate armchair

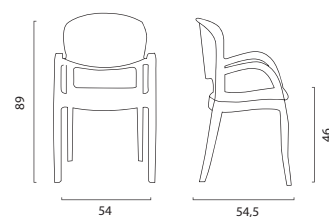

Dimensioni / Dimensions (cm.)

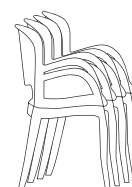

Sedia impilabile
Stackable chair



Dati tecnici e logistici / Technical & logistic details

Codice Item code	Codice Ean Ean code	Colore Color	Peso / Weight (Kg.):	4,20
S6612TR	8005465 892711	TRASPARENTE / CRISTAL CLEAR	Imballo pallet / Pallet packing	
S6612TRMAL	8005465 892742	MARRONE CHIARO / LIGHT BROWN	Pz. pallet / Pcs./Pallet :	16
S6612TRRR	8005465 892759	ROSSO RUBINO / RUBY RED	Misure pallet / Pallet dim. (cm.) :	105 x 61 x h. 195
S6612TRYL	8005465 892773	FUMÈ CHIARO / LIGHT SMOKED GREY	Pz. Bilico / Pcs. Truck :	928
			Pz. 40' CTR / Pcs. 40' CTN :	736

Colori / Colors



TRASPARENTE
CRISTAL CLEAR



MARRONE CHIARO
LIGHT BROWN



ROSSO RUBINO
RUBY RED



FUMÈ CHIARO
LIGHT SMOKED GREY

CRISTAL LIGHT

Sedia in policarbonato trasparente
Transparent polycarbonate chair

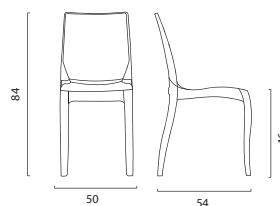

Dimensioni / Dimensions (cm.)

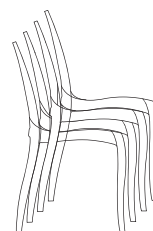

Sedia impilabile
Stackable chair



Dati tecnici e logistici / Technical & logistic details

Codice Item code	Codice Ean Ean code	Colore Color	Peso / Weight (Kg.) :	3,50
S6326TR	8005465 941334	TRASPARENTE / CRISTAL CLEAR	Imballo pallet / Pallet packing	
S6326TRRR	8005465 941341	ROSSO RUBINO / RUBY RED	Pz. pallet / Pcs./Pallet :	16
S6326TRYL	8005465 941358	FUMÈ CHIARO / LIGHT SMOKED GREY	Misure pallet / Pallet dim. (cm.) :	110 x 48 x h. 190
			Pz. Bilico / Pcs. Truck :	1.120
			Pz. 40' CTR / Pcs. 40' CTN :	960

Colori / Colors



TRASPARENTE
CRISTAL CLEAR



ROSSO RUBINO
RUBY RED



FUMÈ CHIARO
LIGHT SMOKED GREY

up[®]
on

Eyes upon us.





HYPNOTIC

Sedia in policarbonato trasparente
Transparent polycarbonate chair

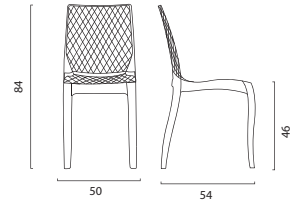

Dimensioni / Dimensions (cm.)

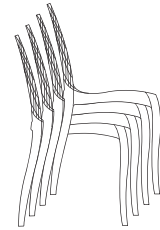

Sedia impilabile / Stackable chair



Dati tecnici e logistici / Technical & logistic details

Codice Item code	Codice Ean Ean code	Colore Color	Peso / Weight (Kg.):
S6319TR	8005465 891561	TRASPARENTE / CRISTAL CLEAR	3,50
S6319TRMAL	8005465 891608	MARRONE CHIARO / LIGHT BROWN	
S6319TRRR	8005465 891592	ROSSO RUBINO / RUBY RED	
S6319TRYL	8005465 891622	FUMÈ CHIARO / LIGHT SMOKED GREY	

Imballo pallet / Pallet packing	
Pz. pallet / Pcs./Pallet :	16
Misure pallet / Pallet dim. (cm.):	110 x 48 x h. 190
Pz. Bilico / Pcs. Truck :	1.120
Pz. 40' CTR / Pcs. 40' CTN :	960

Colori / Colors



TRASPARENTE
CRISTAL CLEAR



MARRONE CHIARO
LIGHT BROWN



ROSSO RUBINO
RUBY RED



FUMÈ CHIARO
LIGHT SMOKED GREY

DUNE

Sedia in policarbonato trasparente
Transparent polycarbonate chair

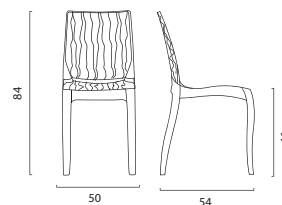

Dimensioni / Dimensions (cm.)

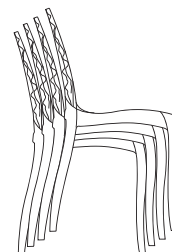

Sedia impilabile
Stackable chair



Dati tecnici e logistici / Technical & logistic details

Codice Item code	Codice Ean Ean code	Colore Color	Peso / Weight (Kg.):	3,50
S6327TR	8005465 941389	TRASPARENTE / CRISTAL CLEAR	Imballo pallet / Pallet packing	
S6327TRMAL	8005465 941396	MARRONE CHIARO / LIGHT BROWN	Pz. pallet / Pcs./Pallet :	16
S6327TRYL	8005465 941433	FUMÈ CHIARO / LIGHT SMOKED GREY	Misure pallet / Pallet dim. (cm.):	110 x 48 x h. 190
			Pz. Bilico / Pcs. Truck :	1.120
			Pz. 40' CTR / Pcs. 40' CTN :	960

Colori / Colors



TRASPARENTE
CRISTAL CLEAR



MARRONE CHIARO
LIGHT BROWN



FUMÈ CHIARO
LIGHT SMOKED GREY



www.up-on.it

LOLLIPOP

Sedia in policarbonato o in **HIGHMOPP**[®]
Gambe in acciaio cromato d. 18x1,5 mm.

Polycarbonate or **HIGHMOPP**[®] & chromed steel
(d. 18x1,5 mm.) chair

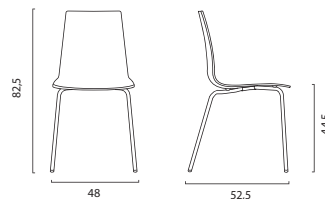

Dimensioni / Dimensions (cm.)

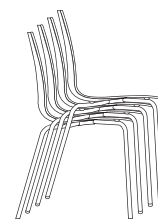

Sedia impilabile
Stackable chair



Dati tecnici e logistici / Technical & logistic details

Codice Item code	Codice Ean Ean code	Colore Color
S3343TR	8005465 891097	TRASPARENTE / CRISTAL CLEAR
S3343TRRR	8005465 891110	ROSSO RUBINO TRASP. / TRANSP. RUBY RED
S3343TRY	8005465 891134	FUMÈ TRASP. / TRANSP. SMOKED GREY
		HIGHMOPP [®]
S3343B	8005465 961400	BIANCO LUCIDO / SOLID GLOSSY WHITE
S3343GP	8005465 967006	GRIGIO PERLA LUCIDO / SOLID GLOSSY PEARL GREY
S3343J	8005465 964920	JUTA LUCIDO / SOLID GLOSSY JUTE
S3343BD	8005465 961639	ROSSO BORDEAUX LUCIDO / SOLID GLOSSY BORDEAUX RED
S3343MK	8005465 967013	MOKA LUCIDO / SOLID GLOSSY MOKA
S3343N	8005465 961417	NERO LUCIDO / SOLID GLOSSY BLACK

Peso policarbonato / Polycarbonate weight (Kg.): 5,40

Peso Highmopp / Highmopp weight (Kg.): 4,50

Imballo pallet / Pallet packing

Pz. pallet / Pcs./Pallet : 12

Misure pallet / Pallet dim. (cm.): 100 x 61 x h. 153

Pz. Bilico / Pcs. Truck : 900

Pz. 40' CTR / Pcs. 40' CTN : 720

Colori / Colors



TRASPARENTE
CRISTAL CLEAR

ROSSO RUBINO
RUBY RED

FUMÈ
SMOKED GREY

BIANCO LUCIDO
SOLID GLOSSY WHITE

NERO LUCIDO
SOLID GLOSSY BLACK

GRIGIO PERLA LUCIDO
GLOSSY PEARL GREY

ROSSO BORDEAUX LUCIDO
GLOSSY BORDEAUX RED

JUTA LUCIDO
GLOSSY JUTE

MOKA LUCIDO
SOLID GLOSSY MOKA



www.up-on.it

CANDY MAT

Sedia polimerica ecologica (Greenpol)
Gambe in acciaio cromato a C, d. 18x1,5 mm.

Green polymeric (Greenpol) chair
(d. 18x1,5 mm.). Stackable chair

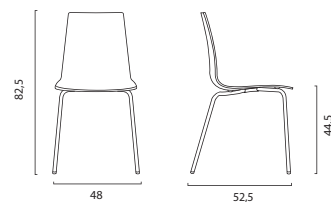

Dimensioni / Dimensions (cm.)

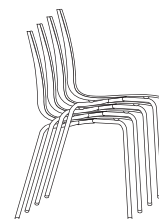

Sedia impilabile
Stackable chair



Dati tecnici e logistici / Technical & logistic details

Codice Item code	Codice Ean Ean code	Colore Color	Greenpol
S3341B	8005465 968065	BIANCO / WHITE	
S3341GP	8005465 968072	GRIGIO PERLA / PEARL GREY	
S3341J	8005465 968089	JUTA / JUTE	
S3341BD	8005465 968096	ROSSO BORDEAUX / BORDEAUX RED	
S3341MK	8005465 968102	MOKA	
S3341BA	8005465 968928	BLU AVIO / AVIO BLUE	
S3341GB	8005465 968935	GIALLO / YELLOW	
S3341VA	8005465 968942	VERDE ANICE / ANISE GREEN	
S3341VB	8005465 968959	VERDE BRILLANTE / BRILLIANT GREEN	
S3341R	8005465 968966	ROSSO / RED	
S3341N	8005465 968119	NERO / BLACK	

Peso / Weight (Kg.): 4,50

Imballo pallet / Pallet packing

Pz. pallet / Pcs./Pallet :	12
Misure pallet / Pallet dim. (cm.):	100 x 61 x h. 153
Pz. Bilico / Pcs. Truck :	900
Pz. 40' CTR / Pcs. 40' CTN :	720

Colori / Colors





www.up-on.it

GROOVE

Sedia in **HIGHMOPP**[®]
Gambe in acciaio cromato d. 18x1,5 mm.

HIGHMOPP[®] solid glossy chair & chromed steel
(d. 18x1,5 mm.) chair

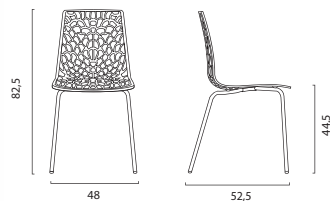

Dimensioni / Dimensions (cm.)

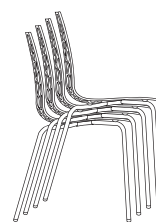

Sedia impilabile
Stackable chair



Dati tecnici e logistici / Technical & logistic details

Codice Item code	Codice Ean Ean code	Colore Color	HIGHMOPP [®]
S3344B	8005465 961363	BIANCO LUCIDO / SOLID GLOSSY WHITE	
S3344BD	8005465 961394	BORDEAUX LUCIDO / SOLID GLOSSY BORDEAUX	
S3344N	8005465 961370	NERO LUCIDO / SOLID GLOSSY BLACK	
S3344VA	8005465 967310	VERDE ANICE LUCIDO / SOLID GLOSSY ANISE GREEN	
S3344MK	8005465 967280	MOKA LUCIDO / SOLID GLOSSY MOKA	
S3344BA	8005465 967297	BLU AVIO LUCIDO / SOLID GLOSSY AVIO BLUE	
S3344GB	8005465 967303	GIALLO LUCIDO / SOLID GLOSSY YELLOW	
S3344GP	8005465 967273	GRIGIO PERLA LUCIDO / SOLID GLOSSY PEARL GREY	
S3344J	8005465 964173	JUTA LUCIDO / SOLID GLOSSY JUTE	

Peso / Weight (Kg.): 3,60

Imballo pallet / Pallet packing

Pz. pallet / Pcs./Pallet :	12
Misure pallet / Pallet dim. (cm.) :	100 x 61 x h. 153
Pz. Bilico / Pcs. Truck :	900
Pz. 40' CTR / Pcs. 40' CTN :	720

Colori / Colors



CALIMA

Sedia in policarbonato trasparente.
Gambe in acciaio cromato d. 18x1,5 mm.

Transparent polycarbonate & chromed steel
(d. 18x1,5 mm.) chair

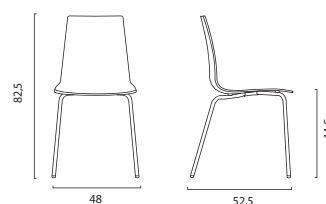

Dimensioni / Dimensions (cm.)

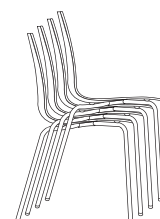

Sedia impilabile
Stackable chair



Dati tecnici e logistici / Technical & logistic details

Codice Item code	Codice Ean Ean code	Colore Color	Peso / Weight (Kg.):	5,30
S3342TR	8005465 891042	TRASPARENTE / CRISTAL CLEAR	Imballo pallet / Pallet packing	
S3342TRRR	8005465 891066	ROSSO RUBINO / RUBY RED	Pz. pallet / Pcs./Pallet :	12
S3342TRY	8005465 891080	FUMÈ / SMOKED GREY	Misure pallet / Pallet dim. (cm.):	100 x 61 x h. 153
S3342TRMAV	8005465 941457	MALVA / PURPLE	Pz. Bilico / Pcs. Truck :	900
			Pz. 40' CTR / Pcs. 40' CTN :	720

Colori / Colors



TRASPARENTE
CRISTAL CLEAR



MALVA
PURPLE



ROSSO RUBINO
RUBY RED



FUMÈ
SMOKED GREY

AETERNA

Sedia in policarbonato trasparente (superficie antigraffio)
Gambe in acciaio cromato d. 18x1,5 mm.

Transparent polycarbonate chair (scratchproof surface)
Chromed steel legs (d. 18x1,5 mm.).

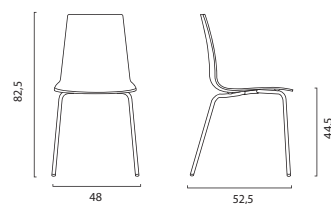

Dimensioni / Dimensions (cm.)

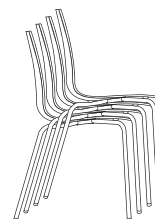

Sedia impilabile
Stackable chair



Dati tecnici e logistici / Technical & logistic details

Codice Item code	Codice Ean Ean code	Colore Color	Peso / Weight (Kg.) :	5,30
S3348TR	8005465 941761	TRASPARENTE / CRISTAL CLEAR	Imballo pallet / Pallet packing	
S3348TRY	8005465 941792	FUMÈ / SMOKED GREY	Pz. pallet / Pcs./Pallet :	12
			Misure pallet / Pallet dim. (cm.) :	100 x 61 x h. 153
			Pz. Bilico / Pcs. Truck :	900
			Pz. 40' CTR / Pcs. 40' CTN :	720

Colori / Colors



TRASPARENTE
CRISTAL CLEAR



FUMÈ
SMOKED GREY





www.up-on.it

LOLLIPOP

Sedia in policarbonato o in **HIGHMOPP**[®]
Base in tondino cromato diam. 11 mm.

Polycarbonate or **HIGHMOPP**[®] chair
Steel-rod chromed base diam. 11 mm.

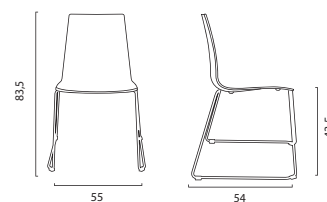

Dimensioni / Dimensions (cm.)



Sedia impilabile
Stackable chair



Dati tecnici e logistici / Technical & logistic details

Codice Item code	Codice Ean Ean code	Colore Color	
S3353TR	8005465 942041	TRASPARENTE / CRISTAL CLEAR	Peso policarbonato / Polycarbonate weight (Kg.): 6,90 Peso Highmopp / Highmopp weight (Kg.): 6,00
S3353TRRR	8005465 942072	ROSSO RUBINO TRASP. / TRANSP. RUBY RED	
S3353TRY	8005465 942089	FUMÈ TRASP. / TRANSP. SMOKED GREY HIGHMOPP [®]	Imballo cartone / Carton box (Da montare / RTA) Pz. cartone / Pcs. box: 4 Dim. cartone / Box size. (cm.) 59 x 55,5 x h. 51 N. cartoni pallet / N. boxes pallet 8 Pz. pallet / Pcs. Pallet : 32 Misure pallet / Pallet dim. (cm.): 120 x 111 x h. 117 Pz. Bilico / Pcs. Truck : 1536 Pz. 40' CTR / Pcs. 40' CTN : 1280
S3353B	8005465 964128	BIANCO LUCIDO / SOLID GLOSSY WHITE	
S3353GP	8005465 967136	GRIGIO PERLA LUCIDO / SOLID GLOSSY PEARL GREY	
S3353J	8005465 967143	JUTA LUCIDO / SOLID GLOSSY JUTE	
S3353BD	8005465 967150	ROSSO BORDEAUX LUCIDO / SOLID GLOSSY BORDEAUX RED	
S3353MK	8005465 967167	MOKA LUCIDO / SOLID GLOSSY MOKA	
S3353N	8005465 964135	NERO LUCIDO / SOLID GLOSSY BLACK	

Colori / Colors



TRASPARENTE CRISTAL CLEAR ROSSO RUBINO RUBY RED FUMÈ SMOKED GREY BIANCO LUCIDO SOLID GLOSSY WHITE NERO LUCIDO SOLID GLOSSY BLACK JUTA LUCIDO GLOSSY JUTE ROSSO BORDEAUX LUCIDO GLOSSY BORDEAUX RED GRIGIO PERLA LUCIDO GLOSSY PEARL GREY MOKA LUCIDO SOLID GLOSSY MOKA

CANDY MAT

Sedia polimerica ecologica (Greenpol)
Gambe in acciaio cromato a C, d. 22 mm.

Green polymeric (Greenpol) chair
(d. 22 mm.). Stackable chair

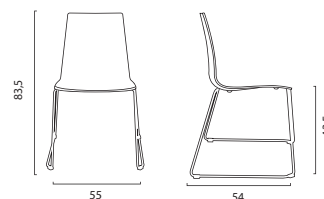

Dimensioni / Dimensions (cm.)

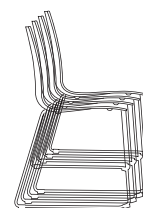

Sedia impilabile
Stackable chair



Dati tecnici e logistici / Technical & logistic details

Codice Item code	Codice Ean Ean code	Colore Color	Greenpol
S3351B	8005465 968126	BIANCO / WHITE	
S3351GP	8005465 968133	GRIGIO PERLA / PEARL GREY	
S3351J	8005465 968140	JUTA / JUTE	
S3351BD	8005465 968157	ROSSO BORDEAUX / BORDEAUX RED	
S3351MK	8005465 968164	MOKA	
S3351BA	8005465 968980	BLU AVIO / AVIO BLUE	
S3351GB	8005465 968997	GIALLO / YELLOW	
S3351VA	8005465 969000	VERDE ANICE / ANISE GREEN	
S3351VB	8005465 969017	VERDE BRILLANTE / BRILLIANT GREEN	
S3351R	8005465 969024	ROSSO / RED	
S3351N	8005465 968171	NERO / BLACK	

Peso / Weight (Kg.): 6,00

Imballo cartone / Carton box (Da montare / RTA)

Cartoni pallet / carton boxes pallet:	4
Dim. cartone / Box size. (cm.)	59 x 55,5 x h. 51
N. cartoni pallet / N. boxes pallet:	8
Pz. pallet / Pcs. Pallet :	32
Misure pallet / Pallet dim. (cm.) :	120 x 111 x h. 117
Pz. Bilico / Pcs. Truck :	1536
Pz. 40' CTR / Pcs. 40' CTN :	1280

Colori / Colors





www.up-on.it

GROOVE

Sedia in **HIGHMOPP**[®]
Base in tondino cromato diam. 11 mm.

HIGHMOPP[®] chair.
Steel-rod chromed base diam. 11 mm.

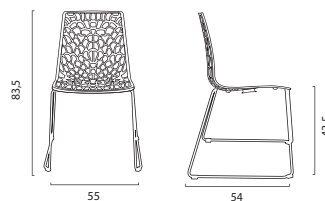

Dimensioni / Dimensions (cm.)



Sedia impilabile
Stackable chair



Dati tecnici e logistici / Technical & logistic details

Codice Item code	Codice Ean Ean code	Colore Color	HIGHMOPP [®]	Peso (kg.) / Weight (Kg.):	5,10
S3354B	8005465 964142	BIANCO LUCIDO / SOLID GLOSSY WHITE		Imballo cartone / Carton box	(Da montare / RTA)
S3354BD	8005465 964937	BORDEAUX LUCIDO / SOLID GLOSSY BORDEAUX		Pz. cartone / Pcs. box:	4
S3354N	8005465 964159	NERO LUCIDO / SOLID GLOSSY BLACK		Dim. cartone / Box size. (cm.)	59 x 55,5 x h. 51
S3354VA	8005465 967365	VERDE ANICE LUCIDO / SOLID GLOSSY ANISE GREEN		N. cartoni pallet / N. boxes pallet	8
S3354MK	8005465 967334	MOKA LUCIDO / SOLID GLOSSY MOKA		Pz. pallet / Pcs. Pallet:	32
S3354BA	8005465 967341	BLU AVIO LUCIDO / SOLID GLOSSY AVIO BLUE		Misure pallet / Pallet dim. (cm.):	120 x 111 x h. 117
S3354GB	8005465 967358	GIALLO LUCIDO / SOLID GLOSSY YELLOW		Pz. Bilico / Pcs. Truck:	1536
S3354GP	8005465 967327	GRIGIO PERLA LUCIDO / SOLID GLOSSY PEARL GREY		Pz. 40' CTR / Pcs. 40' CTN:	1280
S3354J	8005465 964944	JUTA LUCIDO / SOLID GLOSSY JUTE			

Colori / Colors





www.up-on.it

CALIMA

Sedia in policarbonato trasparente.
Base in tondino cromato diam. 11 mm.

Transparent polycarbonate chair.
Steel-rod chromed base diam. 11 mm.

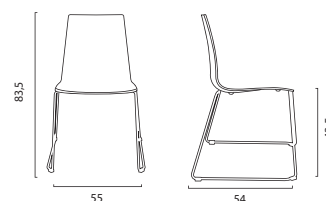

Dimensioni / Dimensions (cm.)



Sedia impilabile
Stackable chair



Dati tecnici e logistici / Technical & logistic details

Codice Item code	Codice Ean Ean code	Colore Color	Peso (kg.) / Weight (Kg.):	6,80
S3352TR	8005465 942140	TRASPARENTE / CRISTAL CLEAR	Imballo cartone / Carton box	(Da montare / RTA)
S3352TRRR	8005465 942164	ROSSO RUBINO / RUBY RED	Pz. cartone / Pcs. box:	4
S3352TRY	8005465 942171	FUMÈ / SMOKED GREY	Dim. cartone / Box size. (cm.)	59 x 55,5 x h. 51
S3352TRMAV	8005465 942157	MALVA / PURPLE	N. cartoni pallet / N. boxes pallet	8
			Pz. pallet / Pcs. Pallet :	32
			Misure pallet / Pallet dim. (cm.) :	120 x 111 x h. 117
			Pz. Bilico / Pcs. Truck :	1536
			Pz. 40' CTR / Pcs. 40' CTN :	1280

Colori / Colors



TRASPARENTE
CRISTAL CLEAR



MALVA
PURPLE



ROSSO RUBINO
RUBY RED



FUMÈ
SMOKED GREY

AETERNA

Sedia in policarbonato trasparente (superficie antigraffio).
Base in tondino cromato diam. 11 mm.

Transparent polycarbonate chair (scratchproof surface).
Steel-rod chromed base diam. 11 mm.

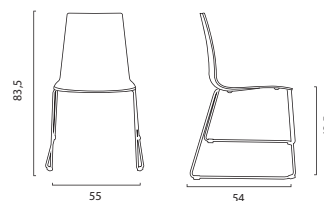

Dimensioni / Dimensions (cm.)



Sedia impilabile
Stackable chair



Dati tecnici e logistici / Technical & logistic details

Codice Item code	Codice Ean Ean code	Colore Color	Peso (kg.) / Weight (Kg.) :	6,80
S3358TR	8005465 942188	TRASPARENTE / CRISTAL CLEAR	Imballo cartone / Carton box	(Da montare / RTA)
S3358TRY	8005465 942218	FUMÈ / SMOKED GREY	Pz. cartone / Pcs. box:	4
			Dim. cartone / Box size. (cm.)	59 x 55,5 x h. 51
			N. cartoni pallet / N. boxes pallet	8
			Pz. pallet / Pcs. Pallet :	32
			Misure pallet / Pallet dim. (cm.):	120 x 111 x h. 117
			Pz. Bilico / Pcs. Truck :	1536
			Pz. 40' CTR / Pcs. 40' CTN :	1280

Colori / Colors



TRASPARENTE
CRISTAL CLEAR



FUMÈ
SMOKED GREY



LOLLIPOP

Sedia impilabile in polycarbonato trasparente o **HIGHMOPP**.
Gambe in acciaio cromato a C, d. 22 mm.

Transparent polycarbonate seat & round chromed steel
or **HIGHMOPP**
(d. 22 mm.). Stackable chair

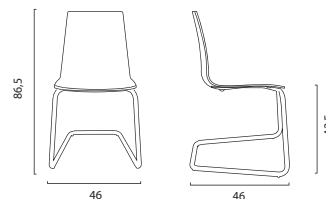

Dimensioni / Dimensions (cm.)



Dati tecnici e logistici / Technical & logistic details

Codice Item code	Codice Ean Ean code	Colore Color	
S3363TR	8005465 942430	TRASPARENTE / CRISTAL CLEAR	Peso polycarbonato / Polycarbonate weight (Kg.): 7,20 Peso Highmopp / Highmopp weight (Kg.): 6,30
S3363TRRR	8005465 942461	ROSSO RUBINO TRASP. / TRANSP. RUBY RED	
S3363TRY	8005465 942478	FUMÈ TRASP. / TRANSP. SMOKED GREY HIGHMOPP	Imballo cartone / Carton box (Da montare / RTA) Cartoni pallet / carton boxes pallet: 4 Dim. cartone / Box size. (cm.): 59 x 55,5 x h. 51 N. cartoni pallet / N. boxes pallet: 8 Pz. pallet / Pcs. Pallet : 32 Misure pallet / Pallet dim. (cm.): 120 x 111 x h. 117 Pz. Bilico / Pcs. Truck : 1536 Pz. 40' CTR / Pcs. 40' CTN : 1280
S3363B	8005465 967624	BIANCO LUCIDO / SOLID GLOSSY WHITE	
S3363GP	8005465 967648	GRIGIO PERLA LUCIDO / SOLID GLOSSY PEARL GREY	
S3363J	8005465 967655	JUTA LUCIDO / SOLID GLOSSY JUTE	
S3363BD	8005465 967631	ROSSO BORDEAUX LUCIDO / SOLID GLOSSY BORDEAUX RED	
S3363MK	8005465 967662	MOKA LUCIDO / SOLID GLOSSY MOKA	
S3363N	8005465 967679	NERO LUCIDO / SOLID GLOSSY BLACK	

Colori / Colors



CANDY MAT

Sedia polimerica ecologica (Greenpol)
Gambe in acciaio cromato a C, d. 22 mm.

Green polymeric (Greenpol) chair
(d. 22 mm.). Stackable chair

www.up-on.it

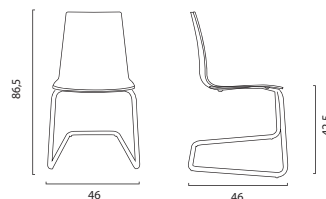

Dimensioni / Dimensions (cm.)



Dati tecnici e logistici / Technical & logistic details

Codice Item code	Codice Ean Ean code	Colore Color
S3361B	8005465 968188	BIANCO / WHITE
S3361GP	8005465 968195	GRIGIO PERLA / PEARL GREY
S3361J	8005465 968201	JUTA / JUTE
S3361BD	8005465 968218	ROSSO BORDEAUX / BORDEAUX RED
S3361MK	8005465 968225	MOKA
S3361BA	8005465 969048	BLU AVIO / AVIO BLUE
S3361GB	8005465 969055	GIALLO / YELLOW
S3361VA	8005465 969062	VERDE ANICE / ANISE GREEN
S3361VB	8005465 969079	VERDE BRILLANTE / BRILLIANT GREEN
S3361R	8005465 969086	ROSSO / RED
S3361N	8005465 968232	NERO / BLACK

Greenpol

Peso / Weight (Kg.): 6,30

Imballo cartone / Carton box (Da montare / RTA)

Cartoni pallet / carton boxes pallet:	4
Dim. cartone / Box size. (cm.)	59 x 55,5 x h. 51
N. cartoni pallet / N. boxes pallet:	8
Pz. pallet / Pcs. Pallet :	32
Misure pallet / Pallet dim. (cm.):	120 x 111 x h. 117
Pz. Bilico / Pcs. Truck :	1536
Pz. 40' CTR / Pcs. 40' CTN :	1280

Colori / Colors



GROOVE

Sedia impilabile in **HIGHMOPP**[®] lucido.
Gambe in acciaio cromato a C, d. 22 mm.

HIGHMOPP[®] solid glossy seat & round chromed steel (d. 22 mm.). Stackable chair

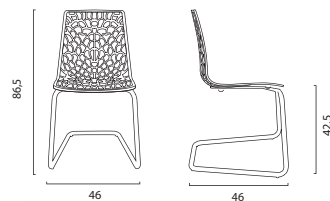

Dimensioni / Dimensions (cm.)



Dati tecnici e logistici / Technical & logistic details

Codice Item code	Codice Ean Ean code	Colore Color	HIGHMOPP [®]	Peso / Weight (Kg.):	5,50
S3364B	8005465 967754	BIANCO LUCIDO / SOLID GLOSSY WHITE			
S3364N	8005465 967778	NERO LUCIDO / SOLID GLOSSY BLACK			
S3364GP	8005465 967822	GRIGIO PERLA LUCIDO / SOLID GLOSSY PEARL GREY			
S3364MK	8005465 967792	MOKA LUCIDO / SOLID GLOSSY MOKA			
S3364BA	8005465 967808	BLU AVIO LUCIDO / SOLID GLOSSY AVIO BLUE			
S3364GB	8005465 967815	GIALLO LUCIDO / SOLID GLOSSY YELLOW			
S3364VA	8005465 967785	VERDE ANICE LUCIDO / SOLID GLOSSY ANISE GREEN			
S3364BD	8005465 967761	BORDEAUX LUCIDO / SOLID GLOSSY BORDEAUX			
S3364J	8005465 967839	JUTA LUCIDO / SOLID GLOSSY JUTE			
				Imballo cartone / Carton box	(Da montare / RTA)
				Cartoni pallet / carton boxes pallet:	4
				Dim. cartone / Box size. (cm.)	59 x 55,5 x h. 51
				N. cartoni pallet / N. boxes pallet:	8
				Pz. pallet / Pcs. Pallet :	32
				Misure pallet / Pallet dim. (cm.) :	120 x 111 x h. 117
				Pz. Bilico / Pcs. Truck :	1536
				Pz. 40' CTR / Pcs. 40' CTN :	1280

Colori / Colors



CALIMA

Sedia impilabile in policarbonato trasparente.
Gambe in acciaio cromato a C, d. 22 mm.

Transparent polycarbonate seat & round chromed steel
(d. 22 mm.). Stackable chair

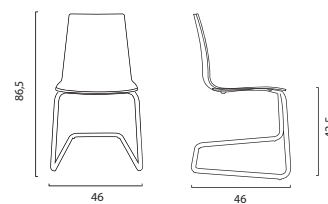

Dimensioni / Dimensions (cm.)



Dati tecnici e logistici / Technical & logistic details

Codice Item code	Codice Ean Ean code	Colore Color	Peso (kg.) / Weight (Kg.) :	7,20
S3362TR	8005465 942539	TRASPARENTE / CRISTAL CLEAR	Imballo cartone / Carton box	(Da montare / RTA)
S3362TRY	8005465 942560	FUMÈ / SMOKED GREY	Cartoni pallet / carton boxes pallet:	4
S3362TRRR	8005465 942553	ROSSO RUBINO / RUBY RED	Dim. cartone / Box size. (cm.)	59 x 55,5 x h. 51
S3362TRMAV	8005465 942546	MALVA / PURPLE	N. cartoni pallet / N. boxes pallet:	8
			Pz. pallet / Pcs. Pallet :	32
			Misure pallet / Pallet dim. (cm.) :	120 x 111 x h. 117
			Pz. Bilico / Pcs. Truck :	1536
			Pz. 40' CTR / Pcs. 40' CTN :	1280

Colori / Colors



TRASPARENTE
CRISTAL CLEAR



MALVA
PURPLE



ROSSO RUBINO
RUBY RED



FUMÈ
SMOKED GREY

SPHERE

Sgabello bar elevabile con seduta in policarbonato e base cromata
Sistema di elevazione a gas
Adjustable barstool with polycarbonate seat & chrome plated base
Gas lift system

www.up-on.it

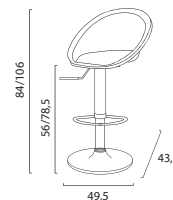

Dimensioni / Dimensions (cm.)



Dati tecnici e logistici / Technical & logistic details

Codice Item code	Codice Ean Ean code	Colore Color	Peso (kg.) / Weight (Kg.) :	7,10
S2805TR	8005465 941242	TRASPARENTE / CRISTAL CLEAR	Imballo cartone / Carton box	
S2805TRY	8005465 941259	FUMÈ / SMOKED GREY	Pz. cartone / Pcs. box:	1
S2805TRRR	8005465 941266	ROSSO RUBINO / RUBY RED	Dim. cartone / Box size. (cm.)	50,5 x 41 x h. 50,5
S2805TRMAV	8005465 941273	MALVA / PURPLE	Pz. pallet / Pcs. Pallet :	16
			Misure pallet / Pallet dim. (cm.) :	120 x 82 x h. 217
			Pz. Bilico / Pcs. Truck :	512
			Pz. 40' CTR / Pcs. 40' CTN :	384

Colori / Colors



MALVA
PURPLE



ROSSO RUBINO
RUBY RED



FUMÈ
SMOKED GREY



TRASPARENTE
CRISTAL CLEAR

SPIDER

Sgabello bar elevabile con seduta in policarbonato o **HIGHMOPP**[®] e base cromata
Sistema di elevazione a gas
Adjustable barstool with polycarbonate **HIGHMOPP**[®] seat & chrome plated base
Gas lift system

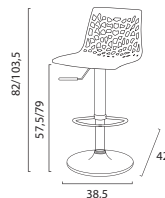

Dimensioni / Dimensions (cm.)



Dati tecnici e logistici / Technical & logistic details

Codice Item code	Codice Ean Ean code	Colore Color	Peso policarbonato / Polycarbonate weight (Kg.):	6,30
S2800TR	8005465 941297	TRASPARENTE / CRISTAL CLEAR HIGHMOPP [®]	Peso Highmopp / Highmopp weight (Kg.):	5,90
S2800BD	8005465 941303	BORDEAUX LUCIDO / SOLID GLOSSY BORDEAUX	Imballo cartone / Carton box	
S2800B	8005465 941310	BIANCO LUCIDO / SOLID GLOSSY WHITE	Pz. cartone / Pcs. box:	1
S2800N	8005465 941327	NERO LUCIDO / SOLID GLOSSY BLACK	Dim. cartone / Box size. (cm.):	51,5 x 28 x h. 51
S2800J	8005465 966870	JUTA LUCIDO / SOLID GLOSSY JUTE	Pz. pallet / Pcs. Pallet :	16
S2800VA	8005465 967211	VERDE ANICE LUCIDO / SOLID GLOSSY ANISE GREEN	Misure pallet / Pallet dim. (cm.):	120 x 83 x h. 117
S2800MK	8005465 967181	MOKA LUCIDO / SOLID GLOSSY MOKA	Pz. Bilico / Pcs. Truck :	1024
S2800BA	8005465 967198	BLU AVIO LUCIDO / SOLID GLOSSY AVIO BLUE	Pz. 40' CTR / Pcs. 40' CTN :	768
S2800GB	8005465 967204	GIALLO LUCIDO / SOLID GLOSSY YELLOW		
S2800GP	8005465 967174	GRIGIO PERLA LUCIDO / SOLID GLOSSY PEARL GREY		

Colori / Colors



TRASPARENTE CRISTAL CLEAR BORDEAUX LUCIDO GLOSSY BORDEAUX BIANCO LUCIDO GLOSSY WHITE NERO LUCIDO GLOSSY BLACK JUTA LUCIDO GLOSSY JUTE VERDE ANICE LUCIDO GLOSSY ANISE GREEN MOKA LUCIDO GLOSSY MOKA BLU AVIO LUCIDO GLOSSY AVIO BLUE GIALLO LUCIDO GLOSSY YELLOW GRIGIO PERLA LUCIDO GLOSSY PEARL GREY

SPHERE

Sgabello con seduta in policarbonato e base in tondino cromato diam. 11 mm.
Stool with polycarbonate seat & steel-rod chromed base diam. 11 mm

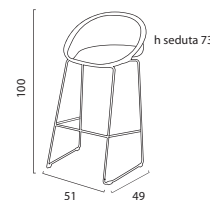

Dimensioni / Dimensions (cm.)



Dati tecnici e logistici / Technical & logistic details

Codice Item code	Codice Ean Ean code	Colore Color	Peso (kg.) / Weight (Kg.):	6,85
S2806TR	8005465 941907	TRASPARENTE / CRISTAL CLEAR	Imballo cartone / Carton box	(Da montare / RTA)
S2806TRY	8005465 941914	FUMÈ / SMOKED GREY	Cartoni pallet / carton boxes pallet:	4
S2806TRRR	8005465 941921	ROSSO RUBINO / RUBY RED	Dim. cartone / Box size. (cm.)	57 x 52 x h. 77
S2806TRMAV	8005465 941938	MALVA / PURPLE	N. cartoni pallet / N. boxes pallet:	10
			Pz. pallet / Pcs. Pallet :	40
			Misure pallet / Pallet dim. (cm.) :	104 x 120 x h. 221
			Pz. Bilico / Pcs. Truck :	1040
			Pz. 40' CTR / Pcs. 40' CTN :	840

Colori / Colors



MALVA
PURPLE



ROSSO RUBINO
RUBY RED



FUMÈ
SMOKED GREY



TRASPARENTE
CRISTAL CLEAR



www.up-on.it

SPIDER

Sgabello con seduta in polycarbonato o **HIGHMOPP**[®] e base in tondino cromato diam. 11 mm.

Stool with polycarbonate or **HIGHMOPP**[®] seat & steel-rod chromed base diam. 11 mm

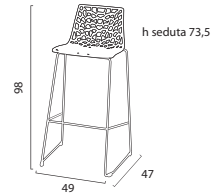

Dimensioni / Dimensions (cm.)



Dati tecnici e logistici / Technical & logistic details

Codice Item code	Codice Ean Ean code	Colore Color	
S2801TR	8005465 941952	TRASPARENTE / CRISTAL CLEAR HIGHMOPP [®]	Peso polycarbonato / Polycarbonate weight (Kg.): 6,10 Peso Highmopp / Highmopp weight (Kg.): 5,70
S2801BD	8005465 961622	BORDEAUX LUCIDO / SOLID GLOSSY BORDEAUX	Imballo cartone / Carton box (Da montare / RTA)
S2801B	8005465 961349	BIANCO LUCIDO / SOLID GLOSSY WHITE	Cartoni pallet / carton boxes pallet: 4
S2801N	8005465 961356	NERO LUCIDO / SOLID GLOSSY BLACK	Dim. cartone / Box size. (cm.): 57 x 52 x h. 77
S2801J	8005465 966931	JUTA LUCIDO / SOLID GLOSSY JUTE	N. cartoni pallet / N. boxes pallet: 10
S2801VA	8005465 967266	VERDE ANICE LUCIDO / SOLID GLOSSY ANISE GREEN	Pz. pallet / Pcs. Pallet: 40
S2801MK	8005465 967235	MOKA LUCIDO / SOLID GLOSSY MOKA	Misure pallet / Pallet dim. (cm.): 104 x 120 x h. 221
S2801BA	8005465 967242	BLU AVIO LUCIDO / SOLID GLOSSY AVIO BLUE	Pz. Bilico / Pcs. Truck: 1040
S2801GB	8005465 967259	GIALLO LUCIDO / SOLID GLOSSY YELLOW	Pz. 40' CTR / Pcs. 40' CTN: 840
S2801GP	8005465 967228	GRIGIO PERLA LUCIDO / SOLID GLOSSY PEARL GREY	

Colori / Colors



up[®]
on

Eyes upon us.





MARTE

Tavolo rettangolare fisso con piano in vetro temperato sp. 10 mm. e 4 gambe in policarbonato a tronco di piramide rovesciato. Piedi in ABS cromato

Fixed rectangular table with 10 mm. tempered glass top and 4 polycarbonate legs. ABS feet, chrome plated.

www.up-on.it

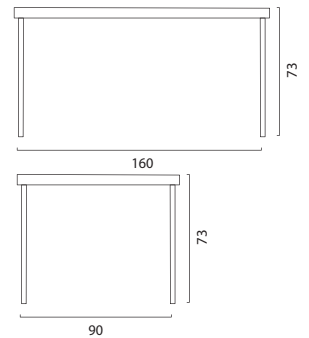

Dimensioni / Dimensions (cm.)



www.up-on.it

MERCURIO

Tavolo quadrato fisso con piano in vetro temperato sp. 10 mm. e 4 gambe in policarbonato a tronco di piramide rovesciato. Piedi in ABS cromato.

Fixed squared table with 10 mm. tempered glass top and 4 polycarbonate legs. ABS feet, chrome plated.

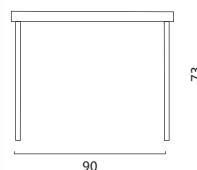

Dimensioni / Dimensions (cm.)

MARTE: RIPIANO RETTANGOLARE / RECTANGULAR TOP

Dati tecnici e logistici / Technical & logistic details

Codice Item code	Codice Ean Ean code	Colore Color	Peso (kg.) / Weight (Kg.) :	37,50
EKF960871	8006544 960871	TRASPARENTE / CRISTAL CLEAR	Imballo cartone / Carton box	
EKF960857	8006544 960857	NERO / BLACK	Pz. cartone / Pcs. box:	1
			Dim. cartone / Box size. (cm.)	172 x 95 x h. 6,0

Colori / Colors



TRASPARENTE
CRISTAL CLEAR



NERO
BLACK

MERCURIO: RIPIANO QUADRATO / SQUARE TOP

Dati tecnici e logistici / Technical & logistic details

Codice Item code	Codice Ean Ean code	Colore Color	Peso (kg.) / Weight (Kg.) :	21,50
EKF960963	8006544 960963	TRASPARENTE / CRISTAL CLEAR	Imballo cartone / Carton box	
EKF960949	8006544 960949	NERO / BLACK	Pz. cartone / Pcs. box:	1
			Dim. cartone / Box size. (cm.)	101 x 95 x h. 4,6

Colori / Colors



TRASPARENTE
CRISTAL CLEAR



NERO
BLACK

MARTE & MERCURIO: SET 4 GAMBE / SET 4 LEGS

Dati tecnici e logistici / Technical & logistic details

Codice Item code	Codice Ean Ean code	Colore Color	Peso del set (kg.) / Weight set (Kg.) :	5,40
S9300TR	8005465 941846	TRASPARENTE / CRISTAL CLEAR	Imballo cartone / Carton box	
S9300TRY	8005465 941853	FUMÈ TRASPARENTE / TRANSPARENT SMOKED GREY	Cartoni pallet / carton boxes pallet:	1
			Dim. cartone / Box size. (cm.)	69 x 24 x h. 18,5

Colori / Colors



TRASPARENTE
CRISTAL CLEAR



FUMÈ TRASPARENTE
TRANSPARENT SMOKED GREY





SUNSHINE

Sedia impilabile in **HIGHMOPP**[®]

HIGHMOPP[®] Stackable chair

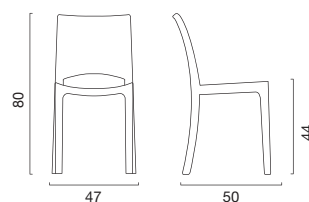

Dimensioni / Dimensions (cm.)

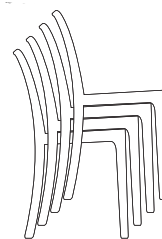

Sedia impilabile
Stackable chair



Dati tecnici e logistici / Technical & logistic details

Codice Item code	Codice Ean Ean code	Colore Color	HIGHMOPP [®]
S6215B	8005465 960878	BIANCO LUCIDO / GLOSSY WHITE	
S6215R	8005465 960885	ROSSO LUCIDO / GLOSSY RED	
S6215N	8005465 960892	NERO LUCIDO / GLOSSY BLACK	
S6215J	8005465 960908	JUTA LUCIDO / GLOSSY JUTE	
S6215VA	8005465 967082	VERDE ANICE LUCIDO / GLOSSY ANISE GREEN	
S6215MK	8005465 967099	MOKA LUCIDO / GLOSSY MOKA	
S6215BA	8005465 967105	BLU AVIO LUCIDO / GLOSSY AVIO BLUE	
S6215GB	8005465 967112	GIALLO LUCIDO / GLOSSY YELLOW	
S6215GP	8005465 967129	GRIGIO PERLA LUCIDO / GLOSSY PEARL GREY	

Peso / Weight (Kg.): 3,50

Imballo pallet / Pallet packing

Pz. pallet / Pcs./Pallet :	18
Misure pallet / Pallet dim. (cm.) :	100 x 48 x h. 190
Pz. Bilico / Pcs. Truck :	1.260
Pz. 40' CTR / Pcs. 40' CTN :	1.080

Colori / Colors



FASHION

Sedia impilabile in **HIGHMOPP**[®]
HIGHMOPP[®] Stackable chair

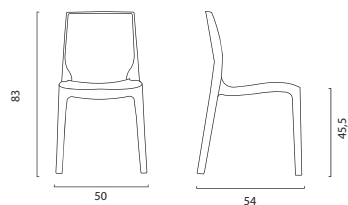

Dimensioni / Dimensions (cm.)

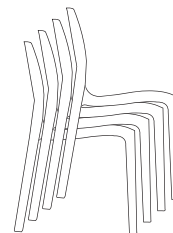

Sedia impilabile
Stackable chair



Dati tecnici e logistici / Technical & logistic details

Codice Item code	Codice Ean Ean code	Colore Color	HIGHMOPP [®]	Peso / Weight (Kg.) :	2,60
S6226B	8005465 961219	BIANCO LUCIDO / GLOSSY WHITE		Imballo pallet / Pallet packing	
S6226N	8005465 961226	NERO LUCIDO / GLOSSY BLACK		Pz. pallet / Pcs./Pallet :	20
S6226J	8005465 961257	JUTA LUCIDO / GLOSSY JUTE		Misure pallet / Pallet dim. (cm.) :	105 x 48 x h. 205
				Pz. Bilico / Pcs. Truck :	1.400
				Pz. 40' CTR / Pcs. 40' CTN :	1.200

Colori / Colors



BIANCO LUCIDO
GLOSSY WHITE



NERO LUCIDO
GLOSSY BLACK



JUTA LUCIDO
GLOSSY JUTE

TEMPTRESS

Sedia impilabile in **HIGHMOPP**[®]
HIGHMOPP[®] Stackable chair

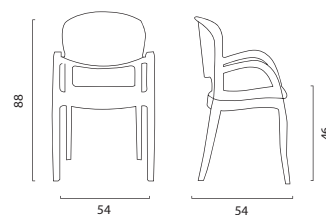

Dimensioni / Dimensions (cm.)

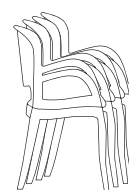

Sedia impilabile
Stackable chair



Dati tecnici e logistici / Technical & logistic details

Codice Item code	Codice Ean Ean code	Colore Color	HIGHMOPP [®]	Peso / Weight (Kg.) :	3,10
S6512B	8005465 961165	BIANCO LUCIDO / GLOSSY WHITE		Imballo pallet / Pallet packing	
S6512N	8005465 961172	NERO LUCIDO / GLOSSY BLACK		Pz. x pallet / Pcs. Pallet :	18
				Misure pallet / Pallet dim. (cm.) :	61 x 106 x h. 206
				Pz. Bilico / Pcs. Truck :	1.044
				Pz. 40' CTR / Pcs. 40' CTN :	828

Colori / Colors



BIANCO LUCIDO
GLOSSY WHITE



NERO LUCIDO
GLOSSY BLACK

FLORENCE

Sedia impilabile in **HIGLOPP**[®]
HIGLOPP[®] Stackable hair

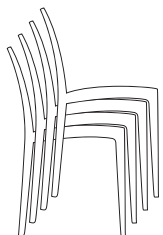

Sedia impilabile
Stackable chair

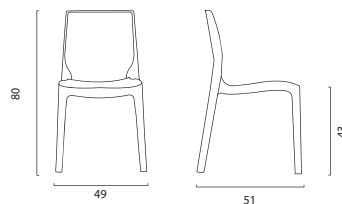

Dimensioni / Dimensions (cm.)

Dati tecnici e logistici / Technical & logistic details

Codice Item code	Codice Ean Ean code	Colore Color	HIGLOPP [®]	Peso / Weight (Kg.):	3,10
S6314HGB	8005465 892599	BIANCO LUCIDO / GLOSSY WHITE		Imballo pallet / Pallet packing	
S6314HGR	8005465 892605	ROSSO LUCIDO / GLOSSY RED		Pz. pallet / Pcs./Pallet :	22
S6314HGY	8005465 892612	ANTR. LUCIDO / GLOSSY ANTHRACITE		Misure pallet / Pallet dim. (cm.) :	90 x 48 x h. 227
				Pz. Bilico / Pcs. Truck :	1.540
				Pz. 40' CTR / Pcs. 40' CTN :	1.320

Colori / Colors



BIANCO LUCIDO
GLOSSY WHITE



ROSSO LUCIDO
GLOSSY RED



ANTRACITE LUCIDO
GLOSSY ANTHRACITE

LONDON

Sedia impilabile in **HIGLOPP®**
HIGLOPP® Stackable chair

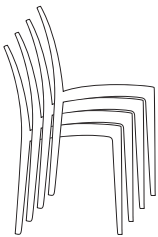

Sedia impilabile
Stackable chair

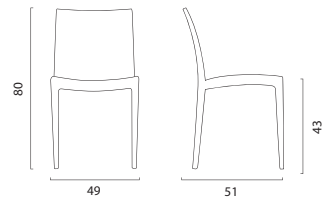

Dimensioni/Dimensions (cm.)

Dati tecnici e logistici / Technical & logistic details

Codice Item code	Codice Ean Ean code	Colore Color	HIGLOPP®	Peso / Weight (Kg.):	3,20
S6324B	8005465 941198	BIANCO LUCIDO / GLOSSY WHITE		Imballo pallet / Pallet packing	
S6324Y	8005465 941204	ANTRACITE LUCIDO / GLOSSY ANTHRACITE		Pz. pallet / Pcs./Pallet :	22
S6324MZ	8005465 941228	MELANZANA LUCIDO / GLOSSY PURPLE		Misure pallet / Pallet dim. (cm.):	105 x 48 x h. 227
				Pz. Bilico / Pcs. Truck :	1.540
				Pz. 40' CTR / Pcs. 40' CTN :	1.320

Colori / Colors



BIANCO LUCIDO
GLOSSY WHITE



ANTRACITE LUCIDO
GLOSSY ANTHRACITE



MELANZANA LUCIDO
GLOSSY PURPLE

ICE

Sedia impilabile in **HIGLOPP**[®]
HIGLOPP[®] Stackable chair

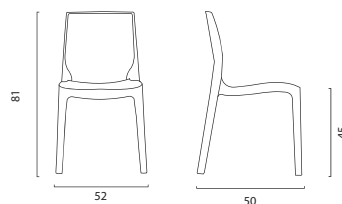

Dimensioni / Dimensions (cm.)

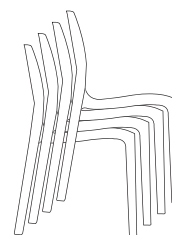

Sedia impilabile
Stackable chair



Dati tecnici e logistici / Technical & logistic details

Codice Item code	Codice Ean Ean code	Colore Color	HIGLOPP [®]	Peso / Weight (Kg.):	3,70
S6317B	8005465 890854	BIANCO LUCIDO / GLOSSY WHITE			
S6317R	8005465 890861	ROSSO LUCIDO / GLOSSY RED			
S6317Y	8005465 890878	ANTRACITE LUCIDO / GLOSSY ANTHRACITE			
S6317VA	8005465 892513	VERDE ANICE LUCIDO / ANISEGLOSSY GREEN			
S6317MZ	8005465 892520	MELANZANA LUCIDO / GLOSSY PURPLE			
S6317BA	8005465 966795	BLU AVIO LUCIDO / GLOSSY AVIO BLUE			
S6317GB	8005465 966801	GIALLO LUCIDO / GLOSSY YELLOW			
S6317GP	8005465 966818	GRIGIO PERLA LUCIDO / GLOSSY PEARL GREY			
S6317J	8005465 960861	JUTA LUCIDO / GLOSSYJUTE			
				Imballo pallet / Pallet packing	
				Pz. pallet / Pcs./Pallet :	18
				Misure pallet / Pallet dim. (cm.) :	110 x 48 x h. 184
				Pz. Bilico / Pcs. Truck :	1.296
				Pz. 40' CTR / Pcs. 40' CTN :	1.062

Colori / Colors



BIANCO LUCIDO
GLOSSY WHITE

ROSSO LUCIDO
GLOSSY RED

ANTRACITE LUCIDO
GLOSSY ANTHRACITE

VERDE ANICE LUCIDO
ANISE GLOSSY GREEN

MELANZANA LUCIDO
GLOSSY PURPLE

BLU AVIO LUCIDO
GLOSSY AVIO BLUE

GRIGIO PERLA LUCIDO
GLOSSY PEARL GREY

GIALLO LUCIDO
GLOSSY YELLOW

JUTA LUCIDO
GLOSSY JUTE

CREAM

Poltroncina impilabile **HIGLOPP**[®]
Stackable **HIGLOPP**[®] armchair

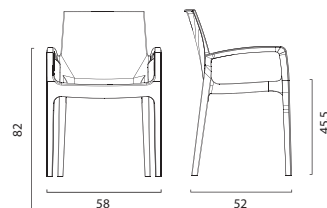

Dimensioni/Dimensions (cm.)

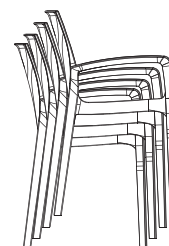

Sedia impilabile
Stackable chair



Dati tecnici e logistici / Technical & logistic details

Codice Item code	Codice Ean Ean code	Colore Color	HIGLOPP [®]	Peso / Weight (Kg.) :	3,80
S6617B	8005465 941495	BIANCO LUCIDO / GLOSSY WHITE			
S6617R	8005465 941501	ROSSO LUCIDO / GLOSSY RED			
S6617Y	8005465 941518	ANTRACITE LUCIDO / GLOSSY ANTHRACITE			
S6617VA	8005465 967037	VERDE ANICE LUCIDO / GLOSSY ANISE GREEN			
S6617MZ	8005465 967044	MELANZANA LUCIDO / GLOSSY PURPLE			
S6617BA	8005465 967051	BLU AVIO LUCIDO / GLOSSY AVIO BLUE			
S6617GB	8005465 967068	GIALLO LUCIDO / GLOSSY YELLOW			
S6617GP	8005465 967075	GRIGIO PERLA LUCIDO / GLOSSY PEARL GREY			
S6617J	8005465 960915	JUTA LUCIDO / GLOSSY JUTE			

Imballo pallet / Pallet packing	
Pz. pallet / Pcs./Pallet :	20
Misure pallet / Pallet dim. (cm.) :	110 x 61 x h. 217
Pz. Bilico / Pcs. Truck :	1.160
Pz. 40' CTR / Pcs. 40' CTN :	920

Colori / Colors





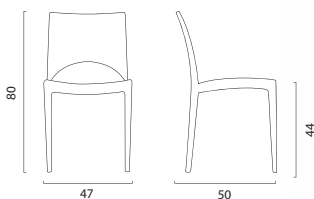

Dimensioni/Dimensions (cm.)

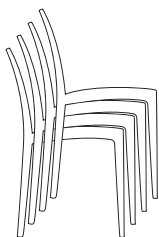

Sedia impilabile
Stackable chair

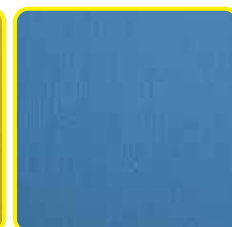
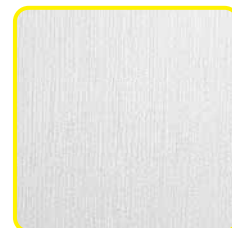
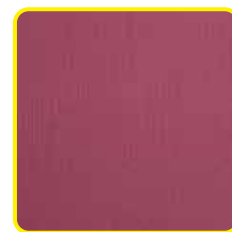

Dati tecnici e logistici / Technical & logistic details

Codice Item code	Codice Ean Ean code	Colore Color
S6015BD	8005465 967907	ROSSO BORDEAUX / BORDEAUX RED
S6015VA	8005465 967938	VERDE ANICE / ANISE GREEN
S6015MK	8005465 967914	MOKA
S6015B	8005465 967884	BIANCO / WHITE
S6015BA	8005465 967891	BLU AVIO / AVIO BLUE
S6015SP	8005465 967921	SENAPE / YELLOW MUSTARD
S6015Y	8005465 967877	ANTRACITE / ANTHRACITE

Peso / Weight (Kg.): 3,50

Imballo pallet / Pallet packing

Pz. pallet / Pcs./Pallet : 22
 Misure pallet / Pallet dim. (cm.): 100 x 48 x h. 212
 Pz. Bilico / Pcs. Truck : 1.540
 Pz. 40' CTR / Pcs. 40' CTN : 1.320

Colori / Colors



ROSSO BORDEAUX
BORDEAUX RED



VERDE ANICE
ANISE GREEN



MOKA



BIANCO
WHITE



BLU AVIO
AVIO BLUE



SENAPE
YELLOW MUSTARD



ANTRACITE
ANTHRACITE

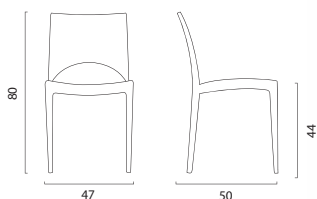

Dimensioni/Dimensions (cm.)

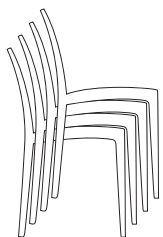

Sedia impilabile
Stackable chair

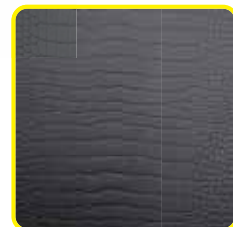

Dati tecnici e logistici / Technical & logistic details

Codice Item code	Codice Ean Ean code	Colore Color
S6115BD	8005465 967686	ROSSO BORDEAUX / BORDEAUX RED
S6115VA	8005465 967716	VERDE ANICE / ANISE GREEN
S6115MK	8005465 967693	MOKA
S6115B	8005465 967853	BIANCO / WHITE
S6115BA	8005465 967860	BLU AVIO / AVIO BLUE
S6115SP	8005465 967709	SENAPE / YELLOW MUSTARD
S6115Y	8005465 967723	ANTRACITE / ANTHRACITE

Peso / Weight (Kg.): 3,50

Imballo pallet / Pallet packing

Pz. pallet / Pcs./Pallet : 22
 Misure pallet / Pallet dim. (cm.): 100 x 48 x h. 212
 Pz. Bilico / Pcs. Truck : 1.540
 Pz. 40' CTR / Pcs. 40' CTN : 1.320

Colori / Colors



ROSSO BORDEAUX
BORDEAUX RED



VERDE ANICE
ANISE GREEN



MOKA



BIANCO
WHITE



BLU AVIO
AVIO BLUE



SENAPE
YELLOW MUSTARD



ANTRACITE
ANTHRACITE

up on[®]

Made in Italy.

www.up-on.it

GRUVYER

Poltrona in polipropilene
Standard polypropilene armchair

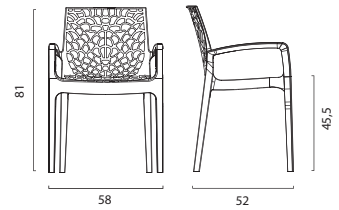

Dimensioni/Dimensions (cm.)

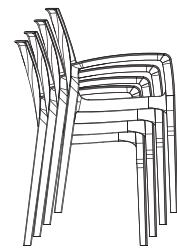

Poltrona impilabile
Stackable armchair



Dati tecnici e logistici / Technical & logistic details

Codice / Item code	Codice Ean / Ean code	Colore / Color
S6626A	8005465 967952	ARANCIO / ORANGE
S6626AV	8005465 967969	AVORIO / IVORY
S6626B	8005465 967945	BIANCO / WHITE
S6626R	8005465 967976	ROSSO / RED
S6626MK	8005465 967983	MOKA
S6626BA	8005465 967990	BLU AVIO / AVIO BLUE
S6626GB	8005465 968003	GIALLO / YELLOW
S6626VA	8005465 968010	VERDE ANICE / ANISE GREEN
S6626GP	8005465 968027	GRIGIO PERLA / PEARL GREY
S6626J	8005465 968034	JUTA / JUTE
S6626VB	8005465 968041	VERDE LUCIDO / GLOSSY GREEN
S6626Y	8005465 968058	ANTRACITE / ANTHRACITE

Peso / Weight (Kg.): 3,80

Imballo pallet / Pallet packing

Pz. pallet / Pcs./Pallet :	20
Misure pallet / Pallet dim. (cm.) :	100 x 61 x h. 217
Pz. Bilico / Pcs. Truck :	1.160
Pz. 40' CTR / Pcs. 40' CTN :	920

Colori / Colors



ARANCIO ORANGE	AVORIO IVORY	BIANCO WHITE	ROSSO RED	MOKA	BLU AVIO AVIO BLUE	GIALLO YELLOW	VERDE ANICE ANISE GREEN	GRIGIO PERLA PEARL GREY	VERDE LUCIDO GLOSSY GREEN	JUTA JUTE	ANTRACITE ANTHRACITE
-------------------	-----------------	-----------------	--------------	------	-----------------------	------------------	----------------------------	----------------------------	------------------------------	--------------	-------------------------

**up
on**[®]

Made in Italy.

www.up-on.it

GRUVYER

Sedia in polipropilene
Standard polypropilene chair

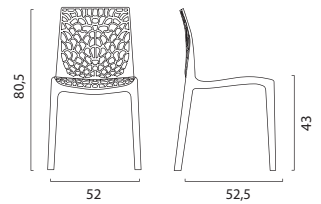

Dimensioni / Dimensions (cm.)

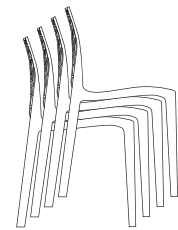

Sedia impilabile
Stackable chair



Dati tecnici e logistici / Technical & logistic details

Codice / Item code	Codice Ean / Ean code	Colore / Color
S6316A	8005465 822602	ARANCIO / ORANGE
S6316AV	8005465 822619	AVORIO / IVORY
S6316B	8005465 822626	BIANCO / WHITE
S6316R	8005465 890335	ROSSO / RED
S6316MK	8005465 822718	MOKA
S6316BA	8005465 966764	BLU AVIO / AVIO BLUE
S6316GB	8005465 966771	GIALLO / YELLOW
S6316VA	8005465 966399	VERDE ANICE / ANISE GREEN
S6316GP	8005465 966412	GRIGIO PERLA / PEARL GREY
S6316J	8005465 966405	JUTA / JUTE
S6316VB	8005465 966788	VERDE LUCIDO / GLOSSY GREEN
S6316Y	8005465 890328	ANTRACITE / ANTHRACITE

Peso / Weight (Kg.): 3,50

Imballo pallet / Pallet packing

Pz. pallet / Pcs./Pallet :	22
Misure pallet / Pallet dim. (cm.) :	110 x 48 x h. 210
Pz. Bilico / Pcs. Truck :	1.584
Pz. 40' CTR / Pcs. 40' CTN :	1.298

Colori / Colors



ARANCIO ORANGE	AVORIO IVORY	BIANCO WHITE	ROSSO RED	MOKA	BLU AVIO AVIO BLUE	GIALLO YELLOW	VERDE ANICE ANISE GREEN	GRIGIO PERLA PEARL GREY	VERDE LUCIDO GLOSSY GREEN	JUTA JUTE	ANTRACITE ANTHRACITE
-------------------	-----------------	-----------------	--------------	------	-----------------------	------------------	----------------------------	----------------------------	------------------------------	--------------	-------------------------



www.up-on.it

PARIS

Sedia in polipropilene
Standard polypropilene chair

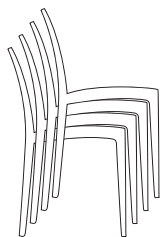

Sedia impilabile
Stackable chair

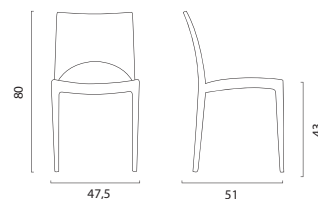

Dimensioni/Dimensions (cm.)

Dati tecnici e logistici / Technical & logistic details

Codice Item code	Codice Ean Ean code	Colore Color	Peso / Weight (Kg.) :	3,10
S6314B	8005465 822213	BIANCO / WHITE	Imballo pallet / Pallet packing	
S6314AV	8005465 822220	AVORIO / IVORY	Pz. pallet / Pcs./Pallet :	24
S6314A	8005465 822237	ARANCIO / ORANGE	Misure pallet / Pallet dim. (cm.) :	90 x 48 x h. 230
S6314MK	8005465 822244	MOKA	Pz. Bilico / Pcs. Truck :	1.680
S6314Y	8005465 822473	ANTRACITE / ANTHRACITE	Pz. 40' CTR / Pcs. 40' CTN :	1.440
S6314R	8005465 822480	ROSSO / RED		
S6314VM	8005465 822497	VERDE MELA / APPLE GREEN		

Colori / Colors



BIANCO
WHITE



AVORIO
IVORY



ARANCIO
ORANGE



MOKA



ANTRACITE
ANTHRACITE



ROSSO
RED



VERDE MELA
APPLE GREEN

PARIS

Poltrona in polipropilene
Standard polypropilene armchair

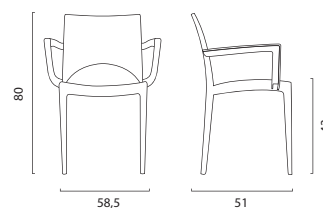

Dimensioni/Dimensions (cm.)

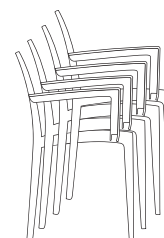

Sedia impilabile
Stackable chair



Dati tecnici e logistici / Technical & logistic details

Codice Item code	Codice Ean Ean code	Colore Color
S6614B	8005465 822282	BIANCO / WHITE
S6614AV	8005465 822299	AVORIO / IVORY
S6614A	8005465 822305	ARANCIO / ORANGE
S6614MK	8005465 822312	MOKA
S6614Y	8005465 822503	ANTRACITE / ANTHRACITE
S6614R	8005465 822510	ROSSO / RED
S6614VM	8005465 822527	VERDE MELA / APPLE GREEN

Peso / Weight (Kg.): 3,40

Imballo pallet / Pallet packing

Pz. pallet / Pcs./Pallet :	24
Misure pallet / Pallet dim. (cm.):	90 x 55 x h. 230
Pz. Bilico / Pcs. Truck :	1.392
Pz. 40' CTR / Pcs. 40' CTN :	1.104

Colori / Colors



BIANCO
WHITE



AVORIO
IVORY



ARANCIO
ORANGE



MOKA



ANTRACITE
ANTHRACITE



ROSSO
RED



VERDE MELA
APPLE GREEN

BOULEVARD

Sedia in polipropilene
con gambe in alluminio

Standard polypropilene chair
with aluminium legs

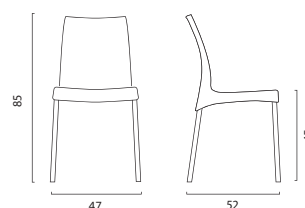

Dimensioni / Dimensions (cm.)

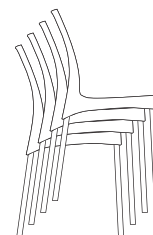

Sedia impilabile
Stackable chair



Dati tecnici e logistici / Technical & logistic details

Codice Item code	Codice Ean Ean code	Colore Color	Peso / Weight (Kg.):	3,00
S3340A	8005465 820851	ARANCIO / ORANGE	Imballo pallet / Pallet packing	
S3340AV	8005465 821193	AVORIO / IVORY	Pz. pallet / Pcs./Pallet :	20
S3340R	8005465 821100	ROSSO / RED	Misure pallet / Pallet dim. (cm.):	100 x 48 x h. 200
S3340VM	8005465 821063	VERDE MELA / APPLE GREEN	Pz. Bilico / Pcs. Truck :	1.400
S3340Y	8005465 821186	ANTRACITE / ANTHRACITE	Pz. 40' CTR / Pcs. 40' CTN :	1.200

Colori / Colors



ARANCIO
ORANGE



AVORIO
IVORY



ROSSO
RED



VERDE MELA
APPLE GREEN



ANTRACITE
ANTHRACITE

BOULEVARD

Poltrona in polipropilene
con gambe in alluminio

Standard polypropylene armchair
with aluminium legs

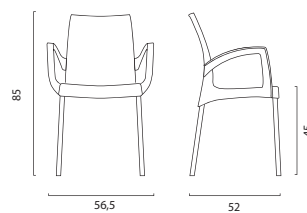

Dimensioni / Dimensions (cm.)

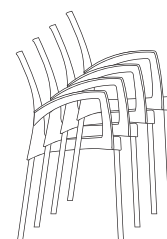

Sedia impilabile
Stackable chair



Dati tecnici e logistici / Technical & logistic details

Codice Item code	Codice Ean Ean code	Colore Color	Peso / Weight (Kg.) :	3,30
S3640A	8005465 820844	ARANCIO / ORANGE	Imballo pallet / Pallet packing	
S3640AV	8005465 821216	AVORIO / IVORY	Pz. pallet / Pcs./Pallet :	16
S3640R	8005465 821117	ROSSO / RED	Misure pallet / Pallet dim. (cm.) :	105 x 61 x h. 210
S3640VM	8005465 821049	VERDE MELA / APPLE GREEN	Pz. Bilico / Pcs. Truck :	928
S3640Y	8005465 821209	ANTRACITE / ANTHRACITE	Pz. 40' CTR / Pcs. 40' CTN :	736

Colori / Colors



ARANCIO
ORANGE



AVORIO
IVORY



ROSSO
RED



VERDE MELA
APPLE GREEN



ANTRACITE
ANTHRACITE

BOULEVARD

Tavolo quadrato in polipropilene
con gambe in alluminio

Standard polypropylene squared
table with aluminium legs

www.up-on.it

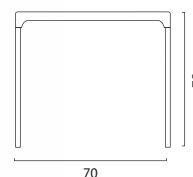

Dimensioni / Dimensions (cm.)

Dati tecnici e logistici / Technical & logistic details

Codice Item code	Codice Ean Ean code	Colore Color	Peso / Weight (Kg.):	4,10
S3940A	8005465 820868	ARANCIO / ORANGE	Imballo pallet / Pallet packing	
S3940AV	8005465 821230	AVORIO / IVORY	Pz. pallet / Pcs./Pallet :	30
S3940R	8005465 821124	ROSSO / RED	Misure pallet / Pallet dim. (cm.):	108 x 108 x h. 220
S3940VM	8005465 821056	VERDE MELA / APPLE GREEN	Pz. Bilico / Pcs. Truck :	720
S3940Y	8005465 821223	ANTRACITE / ANTHRACITE	Pz. 40' CTR / Pcs. 40' CTN :	660

Colori / Colors



ARANCIO
ORANGE



AVORIO
IVORY



ROSSO
RED



VERDE MELA
APPLE GREEN



ANTRACITE
ANTHRACITE



100% Italian ecological evolution

ROME

Sedia polimerica ecologica (Greenpol)
Green polymeric (Greenpol) chair



www.up-on.it

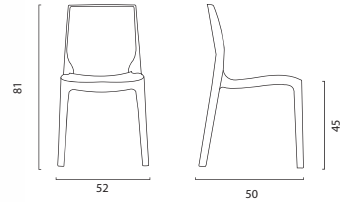

Dimensioni / Dimensions (cm.)

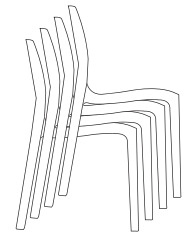

Sedia impilabile
Stackable chair



Dati tecnici e logistici / Commercial & logistic details

Codice / Item code	Codice Ean / Ean code	Colore / Color	Greenpol	Peso / Weight (Kg.) :	3,90
S6217Y	8005465 960977	ANTRACITE / ANTHRACITE			
S6217MK	8005465 966856	MOKA			
S6217J	8005465 961776	JUTA / JUTE			
S6217B	8005465 960946	BIANCO / WHITE			
S6217BA	8005465 966825	BLU AVIO / AVIO BLUE			
S6217GB	8005465 966832	GIALLO / YELLOW			
S6217VA	8005465 966375	VERDE ANICE / ANISE GREEN			
S6217R	8005465 960953	ROSSO / RED			
S6217GP	8005465 966382	GRIGIO PERLA / PEARL GREY			

Imballo pallet / Pallet packing	
Pz. pallet / Pcs./Pallet :	22
Misure pallet / Pallet dim. (cm.) :	100 x 48 x h. 219
Pz. Bilico / Pcs. Truck :	1.584
Pz. 40' CTR / Pcs. 40' CTN :	1.320

Colori / Colors



ANTRACITE ANTHRACITE GIALLO YELLOW JUTA JUTE BIANCO WHITE GRIGIO PERLA PEARL GREY BLU AVIO AVIO BLUE VERDE ANICE ANISE GREEN MOKA ROSSO RED



100% Italian ecological evolution

VENICE

Sedia polimerica ecologica (Greenpol)
Green polymeric (Greenpol) chair



www.up-on.it

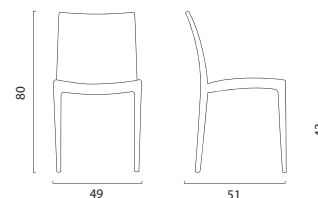

Dimensioni/Dimensions (cm.)

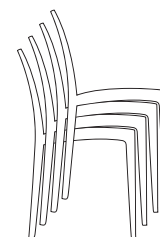

Sedia impilabile
Stackable chair



Dati tecnici e logistici / Commercial & logistic details

Codice Item code	Codice Ean Ean code	Colore Color	Greenpol	Peso / Weight (Kg.) :	3,30
S6224B	8005465 961004	BIANCO / WHITE			
S6224MK	8005465 963886	MOKA			
S6224Y	8005465 961035	ANTRACITE / ANTHRACITE			
S6224J	8005465 961301	JUTA / JUTE			
S6224BA	8005465 966269	BLU AVIO / AVIO BLUE			
S6224GB	8005465 966955	GIALLO / YELLOW			
S6224VA	8005465 966276	VERDE ANICE / ANISE GREEN			
S6224GP	8005465 964814	GRIGIO PERLA / PEARL GREY			
S6224R	8005465 961011	ROSSO / RED			
				Imballo pallet / Pallet packing	
				Pz. pallet / Pcs./Pallet :	22
				Misure pallet / Pallet dim. (cm.) :	105 x 48 x h. 227
				Pz. Bilico / Pcs. Truck :	1.540
				Pz. 40' CTR / Pcs. 40' CTN :	1.320

Colori / Colors



JUTA JUTE BIANCO WHITE ANTRACITE ANTHRACITE MOKA ROSSO RED GRIGIO PERLA PEARL GREY VERDE ANICE ANISE GREEN GIALLO YELLOW BLU AVIO AVIO BLUE



100% Italian ecological evolution

VENICE

Poltrona polimerica ecologica (Greenpol)
Green polymeric (Greenpol) armchair



www.up-on.it

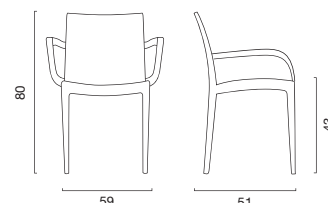

Dimensioni / Dimensions (cm.)

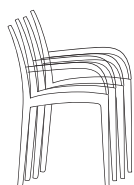

Sedia impilabile
Stackable chair



Dati tecnici e logistici / Commercial & logistic details

Codice Item code	Codice Ean Ean code	Colore Color	Greenpol	Peso / Weight (Kg.):	3,70
S6624B	8005465 961684	BIANCO / WHITE			
S6624MK	8005465 963893	MOKA			
S6624Y	8005465 961769	ANTRACITE / ANTHRACITE			
S6624J	8005465 961714	JUTA / JUTE			
S6624BA	8005465 966962	BLU AVIO / AVIO BLUE			
S6624GB	8005465 966979	GIALLO / YELLOW			
S6624VA	8005465 966986	VERDE ANICE / ANISE GREEN			
S6624GP	8005465 966993	GRIGIO PERLA / PEARL GREY			
S6624R	8005465 961738	ROSSO / RED			

Imballo pallet / Pallet packing	
Pz. pallet / Pcs./Pallet :	22
Misure pallet / Pallet dim. (cm.) :	110 x 61 x h. 227
Pz. Bilico / Pcs. Truck :	1.276
Pz. 40' CTR / Pcs. 40' CTN :	1.012

Colori / Colors



JUTA JUTE BIANCO WHITE ANTRACITE ANTHRACITE MOKA ROSSO RED GRIGIO PERLA PEARL GREY VERDE ANICE ANISE GREEN GIALLO YELLOW BLU AVIO AVIO BLUE

up[®]
on

Eyes upon us.







A circular blue seal with white text is overlaid on the image. In the center, it reads 'PAH 100% free' in large white letters. Surrounding this central text is a ring of text in Arabic and Chinese. The Arabic text reads 'مادة PAH - 100% حرة' and the Chinese text reads 'PAH - 多环芳烃'. The seal has a slightly distressed, paper-like texture.





Via Milano, 202 - 46019 Cogozzo di Viadana (Mn) – Italy

Tel.: +39 0375.790294 - Fax: +39 0375.88439

e-mail: igap@igap.it

Website: www.grandsoleilspa.it



Via Garibaldi, 244 - 46013 Canneto s/Oglio (Mn) – Italy

Tel.: +39 0376.7172200 - +39 0376.723705

Fax: +39 0376.7172290

e-mail: igap@igap.it

Website: www.grandsoleilspa.it

100 x 100 made in Italy